

## AVA456-WHKT / AVA456-BHKT

### ■ Dimensions

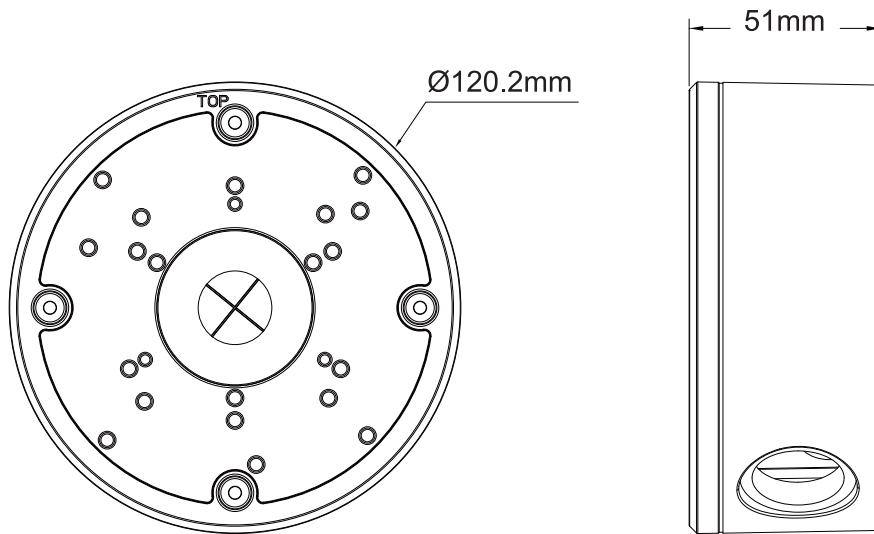

### ■ Installation

Step1: Loosen the four screws on the top cover of the conduit box and unhook the tether wire.

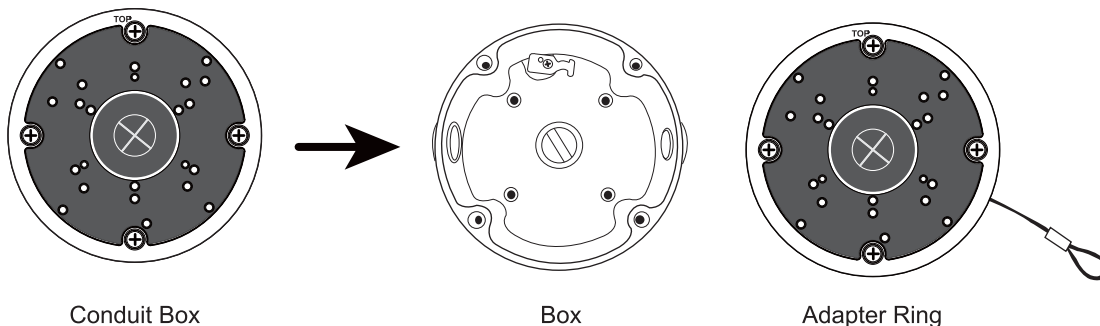

Step2: Arrange how the camera cables are routing.

Then, attach and secure the box to where the camera will be installed.

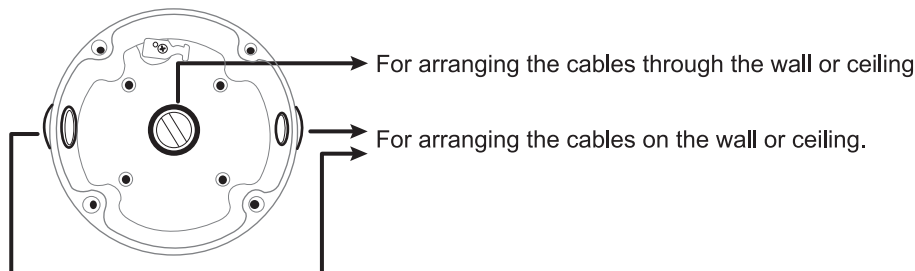

Step3: Pass the camera cables through the middle hole of the adapter ring. Then, align the screw holes of the camera bracket with the holes on the adapter ring as described in "Camera Type and Corresponding Screw Holes" to secure the camera to the adapter ring.

Step4: Attach and fasten the camera to the ring first and to the box.

If needed, you can hook the ring to the box first to make the installation easier.

# AVA456-WHKT / AVA456-BHKT

## ■ Camera Type and Corresponding Screw Holes

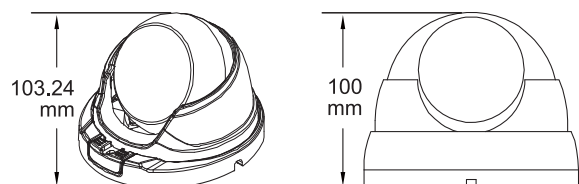
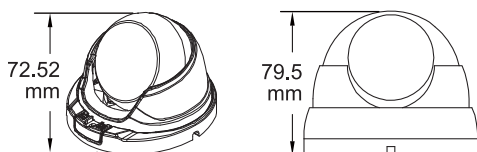
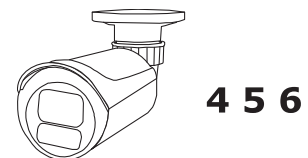
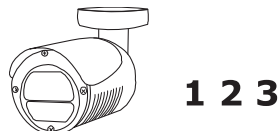
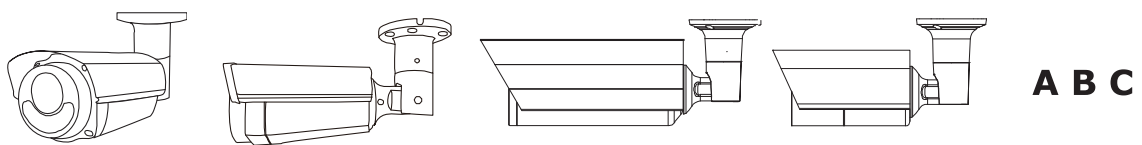
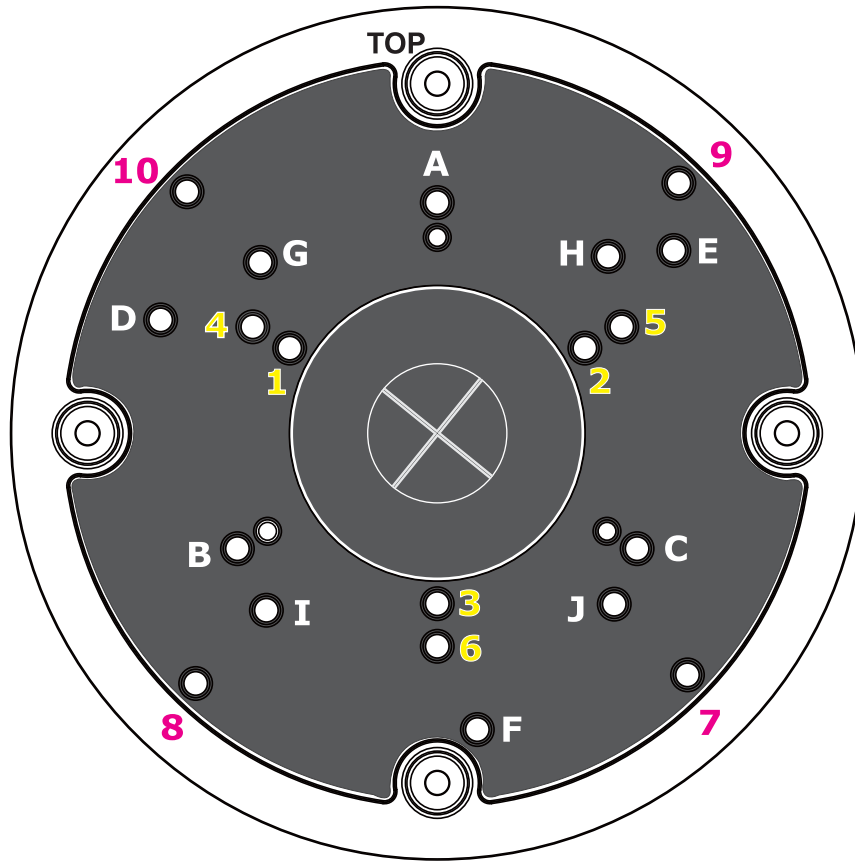

**G H I J**

**7 8 9 10**