

Multilingual Version

[English](#)

[中文](#)

[Deutsch](#)

[Italiano](#)

[Español](#)

HD CCTV RECORDER

QUICK START

■ 2MP ~ 5MP Video Recording

Please read instructions thoroughly before operation and retain it for future reference. For the actual display & operation, please refer to your recorder.

To get the complete user manual and free PC CMS Software (CMS Lite), scan the QR code on the right, or go to the site:

www.surveillance-download.com/user/z404.swf.



1. EAZY NETWORKING SETUP



EaZy Networking is a free P2P cloud service to connect AVTECH devices to the Internet automatically by plug-and-play, enabling you to check the live view via your mobile device or laptop at anytime.

In most cases, the device is connected via P2P. Connection via the relay server is only applied to some complex environments such as the private IP-based network environment used by a large enterprise. There is no speed limitation of P2P connection. For connection via the relay server, the speed is up to 10FPS@512kbps. To obtain stable transmission, it's recommended to purchase our data plan of 1GB or 7GB. Each device will enclose a 2GB data plan for a free trial.

EaZy Networking could be configured via EagleEyes on an iOS / android device, or via Internet Explorer.

Note: The instructions below explain how to configure via the free mobile app, EagleEyes. To know how to configure via Internet Explorer, please check the complete user manual.



Before using this function, make sure:

- This recorder is connected to a switch or router, and the switch or router is ready for Internet connection.
- The network icon on the top right corner is , not .
- You have an iOS / Android mobile device with EagleEyes installed

1.1 Via EagleEyes on iOS / Android Device

1.1.1 Recorder Setup

Step1: Right-click to show the main menu, choose  (ADVANCED CONFIG), and select **NETWORK** → **WAN**.

Set **NETWORK TYPE** to **DHCP**, and make sure the network icon on the top right corner is changed from  to .

Note: **DHCP** allows your router to assign an IP address for your device automatically. There are also **STATIC** and **PPPOE** to choose for the network type. Please choose the one needed for your network environment and get the information needed from your installer or network service provider.

ADVANCED CONFIG	
CAMERA	WAN E-MAIL DDNS PROTOCOL EaZy
DETECTION	NETWORK TYPE DHCP <input checked="" type="checkbox"/>
ALERT	IP 192.168.001.010
NETWORK	GATEWAY 192.168.001.254
DISPLAY	NETMASK 255.255.255.000
RECORD	PRIMARY DNS 8.8.8.8
DEVICES	SECONDARY DNS 168.95.1.1
DCCS	PORT 80
IVS	CHECK INTERNET AVAILABILITY BY ADDRESS www.google.com
NOTIFY	
JOYSTICK	
EXIT	MAC: 00:0E:53:EC:A7:B4

Step2: In the same menu, select **EaZy**. Enable EaZy Networking, and leave this page open. You'll need to scan the QR code later. You'll see either of the setup pages below. Go to "1.1.2 EagleEyes Setup" to know which option you should choose during setup.

Type 1 ("EaZy" on EagleEyes)

WAN	E-MAIL	DDNS	PROTOCOL	EaZy
ENABLE EAZY NETWORKING				ON
				
000E532B8613				

Type 2 (Both "EaZy" and "QR Code" on EagleEyes)

WAN	E-MAIL	DDNS	PROTOCOL	EaZy
ENABLE EAZY NETWORKING				ON
MAC: 000E53ECA7B4				
UUID: e736dcbf-d4bb-4ca8-86fd-62658e2ecec1				
PORT: 80				
				

1.1.2 EagleEyes Setup

Two options can be chosen for EaZy Networking: **EaZy** and **QR Code**. **EaZy** is used for both recorders and IP cameras while **QR Code** is used only for recorders.

When a device is configured to the internet via **EaZy**, the person who configures the device has the administrator permission of this device and also has the power to assign who can access the device remotely, by the web browser of Internet Explorer or the mobile app of EagleEyes.

When a device is configured to the internet via **QR Code**, everyone has the right to access the device as long as he/she is able to scan the QR code of the device. However, he/she can only access the device via the mobile app of EagleEyes. Internet Explorer is not supported.

By QR Code (For Type 2 only)

Step1: Open EagleEyes on your mobile device, and select “**Add**” on the bottom. Then, click **QR Code**.

Step2: Scan the QR code shown on your recorder, and enter the title of this device and its user name and password.

Step3: Make sure you see the device type when you tap **Get Type**. If not, the device is not connected properly. Then, Tap **Apply** to complete the process, and you’re ready to see the live view.

Note: For the first time to connect your device to the internet, the default user name and password are both **admin**. If it’s been configured before, make sure you’ve known its current user name and password since they may be changed for security purpose.

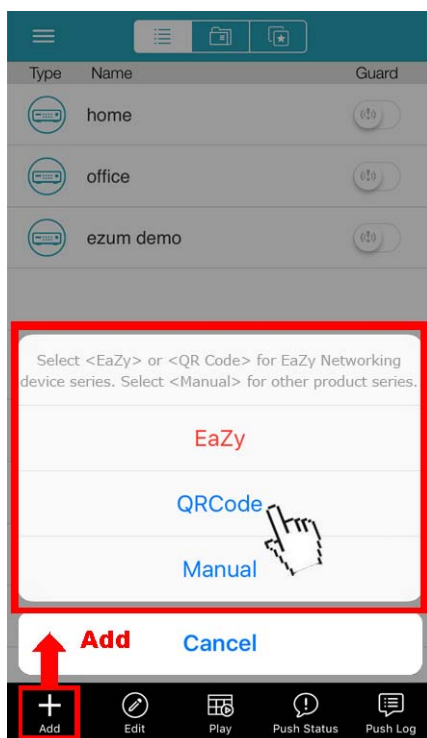



By EaZy (For Type 1 and Type 2)

Step1: Open EagleEyes on your mobile device, and select “...” on the top left corner in the address book. Then, click **EaZy**.

Step2: Click **Login** and register an account for “Cloud Service”. If you’ve got an account, please just log in.

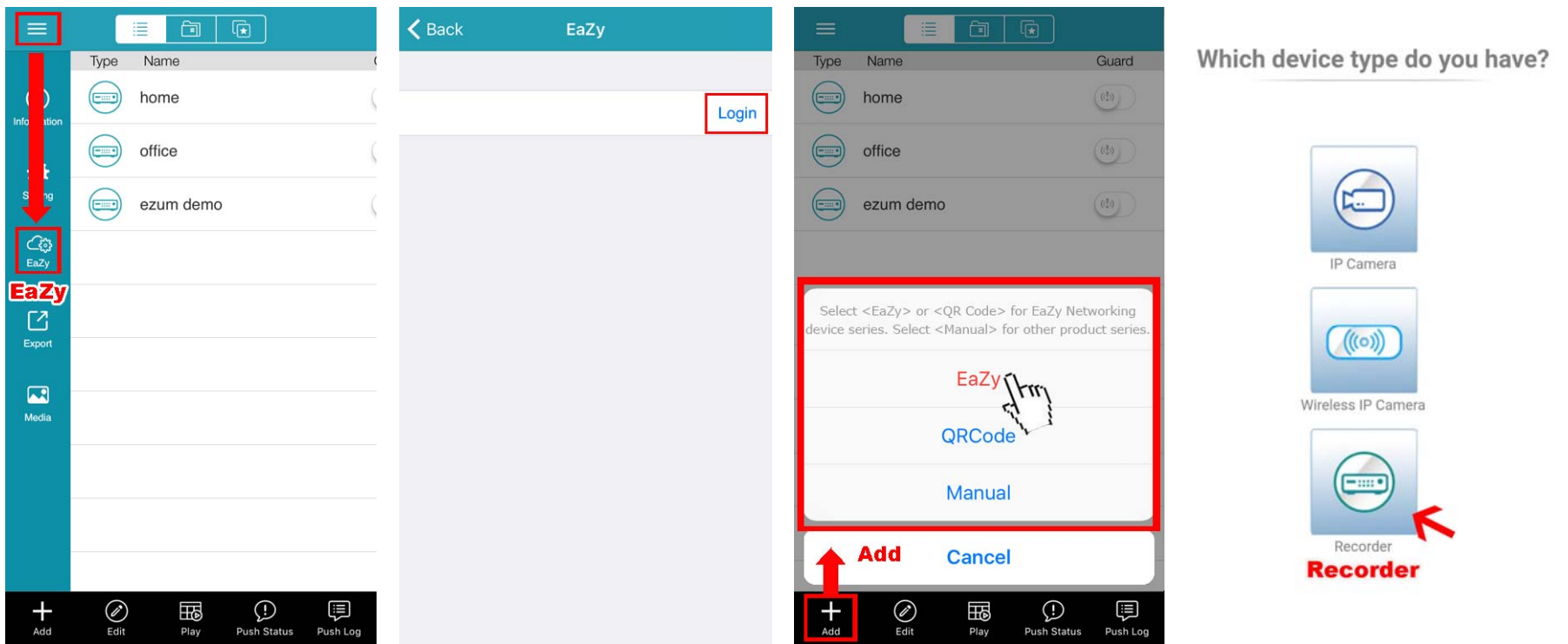
Step3: Go back to the address book and click **+** to add a new device. Select **EaZy**, and choose the recorder icon to continue.



Step4: Click  in the section of **MAC address** to open the QR code scan page, and scan the QR code on the recorder screen mentioned in Step2. The MAC address will be filled automatically. Fill in the Captcha code manually, and click **Apply**.

Step5: Follow the on-screen instruction to finish the rest of the settings, and see if this device is added successfully to the address book as a cloud device.

At the same time, you'll be prompted to confirm if you want to remove the default user name and password.

- When the default user name and password are removed, you can **ONLY** use the user name and password of the cloud service to access this recorder locally and remotely. If you forget the user name and password of the cloud service, you could only reset the recorder and do all configurations again.
- When the default user name and password are kept, other people might be able to access this recorder if they know the default user name and password of this recorder.

Confirm if you want to keep the default account to continue, and return to the address book. You'll see the newly-added device in the address with a cloud icon on it.



Step6: Click the newly-added device and see if you could access successfully.

2. CONNECTION AND SETUP

Before the recorder is powered on, make sure you have installed a hard disk, connected at least one camera and a HDMI monitor. For details, please refer to the following sections.

Note: The recorder is designed to automatically detect the video system of the connected cameras (NTSC or PAL). To make sure the system detection is correct, please check if the cameras are connected to the recorder and power-supplied before the recorder is powered on.

2.1 SATA Hard Disk Installation

At least a hard disk is necessary for the recorder to save video footage, and firmware upgrade might be failed if there's no hard disk installed in this recorder.

Either of the following two types of hard disk installation is applicable for your recorder model. Please check the instructions below to see which installation method is the right one for your recorder to install a hard disk.

➤ Type 1

Note: Here takes an 8CH model as an example of how to connect a hard disk to your device. To know how many hard disks could be installed, please refer to the specifications of your device.

Step1: Remove the top cover, and find the hard disk connector and bracket in the device.

Step2: Get a compatible hard disk. With the PCB side facing down, insert the hard disk to one of the hard disk connector.

Note: To use a green hard disk, use **ONLY** the hard disk designed especially for surveillance to ensure the device works properly.

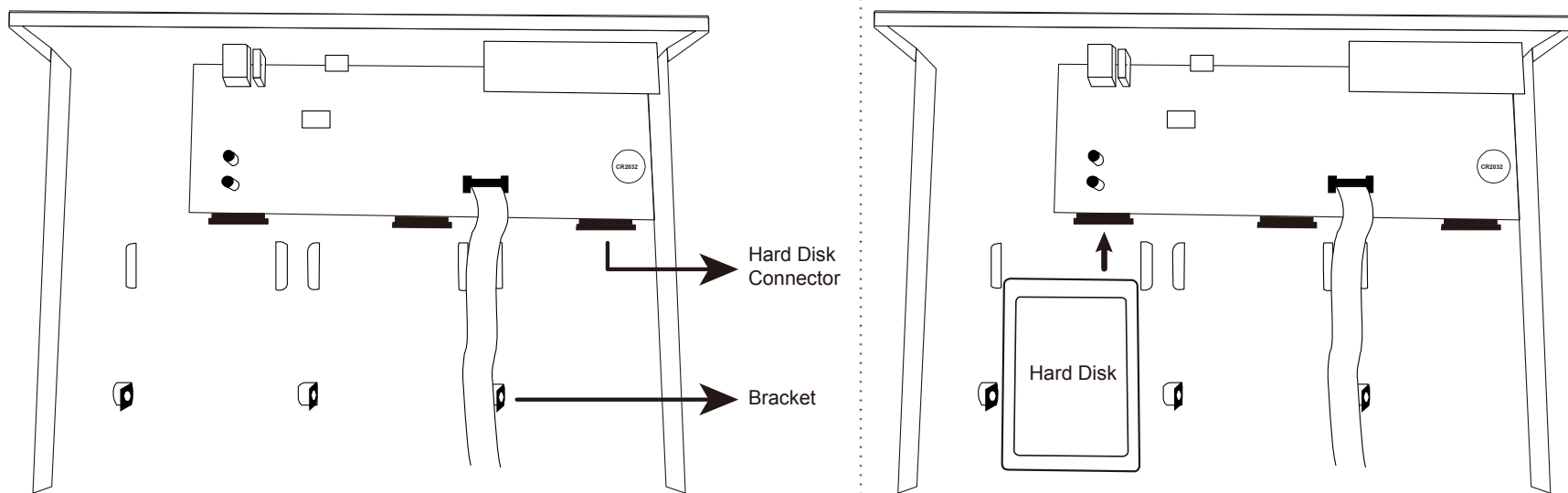

Step3: Fasten the hard disk to the bracket by securing the screw on the bracket.

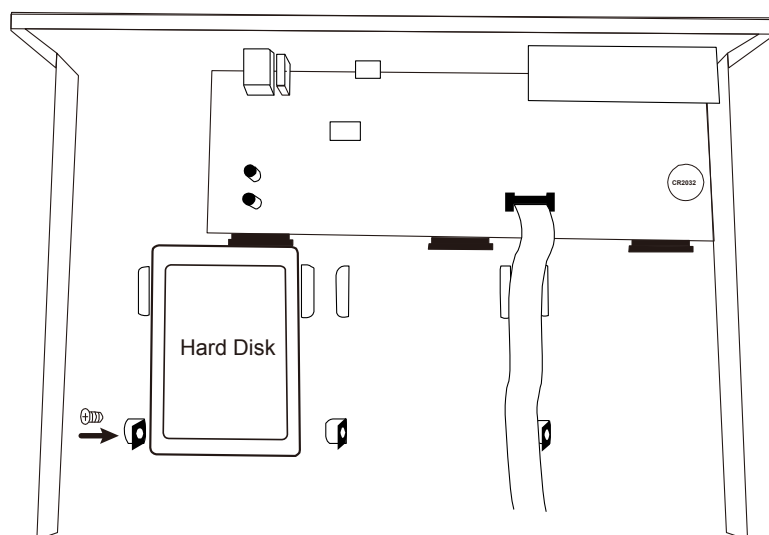

Step4: Replace the top cover and fasten the screws you loosened in Step1.

➤ Type 2

Note: Here takes an 8CH model as an example of how to connect a hard disk to your device. To know how many hard disks could be installed, please refer to the specifications of your device.

Step1: Remove the top cover, and find where to install a hard disk.

Step2: Get a compatible hard disk. With the PCB side facing down, find the screw holes on the recorder base, and place the hard disk in the recorder.

Note: To use a green hard disk, use **ONLY** the hard disk designed especially for surveillance to ensure the device works properly.

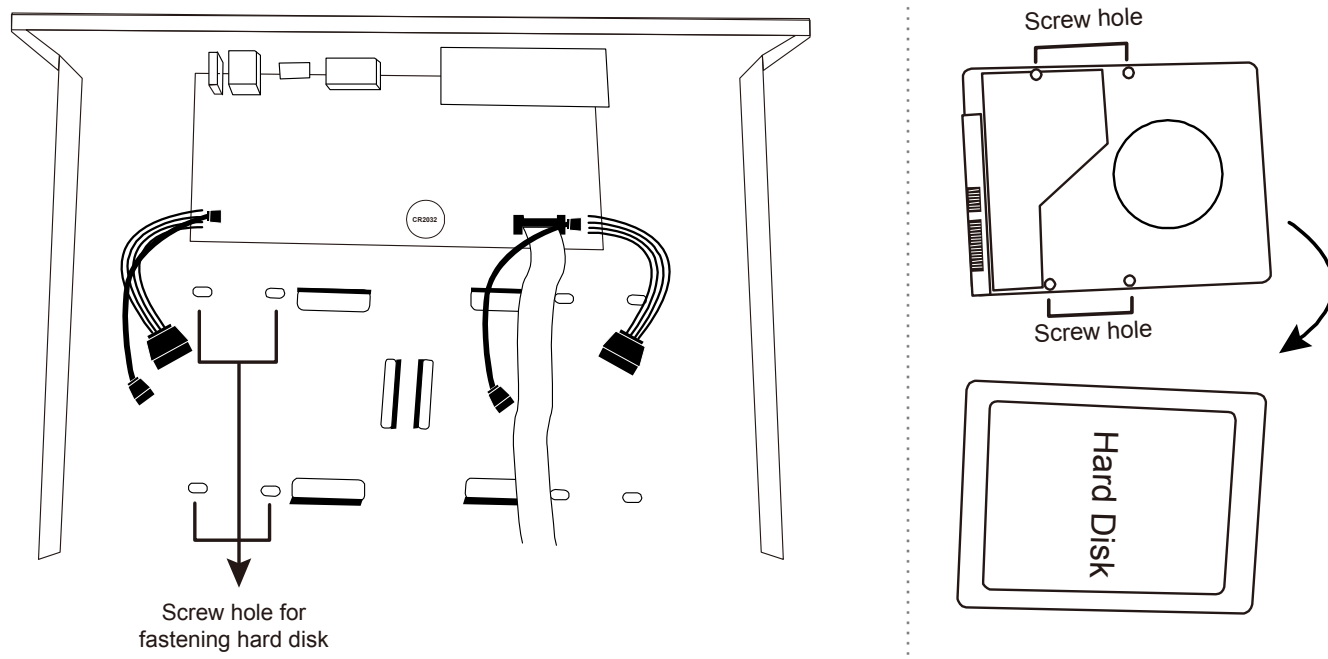

Step3: Align the screw holes on the base and the hard disk. Then, fasten the hard disk on the base with the supplied screws from the bottom side of the recorder.

Step4: Connect the data bus and power cable for the hard disk.

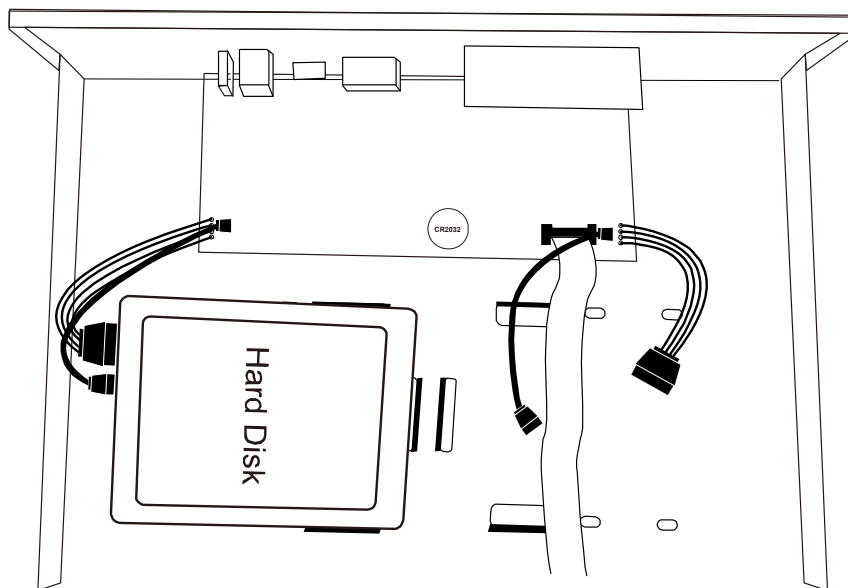

Step5: Replace the top cover and fasten the screws you loosened in Step1.

Step6: Remove the protective film on the bottom of the recorder if any to ensure the heat dissipation can work normally.

2.2 Camera Connection

Install the camera on the wall or ceiling based on your installation environment and camera type. For installation details, please refer to the user manual of your camera.

2.2.1 Normal Camera

- STEP 1: Connect the coaxial cable to the recorder.
 STEP 2: (Optional) Connect the audio cable to the recorder.
 STEP 3: Power on the camera and see if the live video shows.

2.2.2 HD CCTV Camera Series











- STEP 1: Connect the coaxial cable to the recorder.
 STEP 2: Power on the camera and see if the live video shows.
 STEP 3: On the recorder side, right click to show the main menu, and go to  (ADVANCED CONFIG) → **DCCS** → **OSD MENU** to configure the camera if needed.

ADVANCED CONFIG	
CAMERA	CH1 CH2 CH3 CH4
DETECTION	OSD MENU SETUP
ALERT	DCCS MENU SETUP
NETWORK	
DISPLAY	
RECORD	
DEVICES	
DCCS	
IVS	F.W. 1017
NOTIFY	DEVICE AVT Series
JOYSTICK	CONNECTION OK
EXIT	

EZUM Camera Series

If the cameras you connected are our EZUM camera series, we have also designed a series of icons for quick camera setup. Based on the EZUM camera type connected, you may find some of the icons as listed below for quick camera configurations, and the sub-functions of each icon may also vary based on the camera connected.

Path: Bottom left on each camera channel view → .

	Day & Night Configure the day and night modes of the camera		IR Management Manually adjust the brightness of IR LEDs.
	Noise Reduction Reduce image noise if needed.		Optics Manually change the shutter speed if needed.
	Color Manually adjust the color-related parameters if needed.		Image Enhancement Enhance the image performance for better sharpness and overall identification even in overexposure areas.
	Zoom Used with the motorized lens cameras for optical zoom.		Hot Point Click on the screen to move the surveillance area to the point just clicked.
	PTZ Control Open the PTZ control panel to pan, tilt, zoom and cruise the camera.		Advanced Set other camera parameters such as camera system, and mirroring or flipping camera images.

2.2.3 Other brand's speed dome camera

Note: The recorder must support RS485 connection to connect a speed dome camera. Please check the specifications of your recorder for details.

- STEP 1: Connect the coaxial cable to the recorder.
 STEP 2: Find where the connectors of RS485-A and RS485-B are located on the rear panel of the recorder, and follow the instructions of your camera manual to connect to the recorder. Then, power on the camera.
 STEP 3: On the recorder side, right click to show the main menu, and go to  (ADVANCED CONFIG) → **DEVICES** to set the camera.

- a) Select the device to **PTZ**.
- b) Set the ID to the value the same as the one set in the camera.
- c) Select the protocol to **P-P**, **P-D**, **S-T** or **S-E**.

Note: **P-P** and **P-D** are protocols used Pelco, and **S-T** and **S-E** are protocols used by Samsung.

- d) Set the baud rate to the value the same as the one set in the camera.
- e) Set the interface to **RS485**.

ADVANCED CONFIG	
CAMERA	CH1 CH2 CH3 CH4
DETECTION	DEVICE PTZ
ALERT	ID 000
NETWORK	PROTOCOL P-P
DISPLAY	RATE 2400
RECORD	INTERFACE RS485
DEVICES	
DCCS	
IVS	
NOTIFY	
JOYSTICK	
EXIT	

2.2.4 IP Camera

Note: Check the specifications of your recorder and see if the recorder supports IP camera connection.

STEP 1: Connect the camera to the same switch / router as the one the recorder is connected, and power on the camera.

STEP 2: On the recorder side, move the cursor to the left to show the quick bar, and choose  (IP Search) to find your camera.

IP SEARCH					
IP	PORT	MAC	TYPE	PROTOCOL	STATUS
10.1.1.12	88	00:0e:53:e5:9a:f1	IP CAMERA	AVTECH	UNUSED
10.1.1.12	88	UNKNOWN	IP CAMERA	ONVIF	UNUSED
↑			CONNECT	SETUP	EXIT

STEP 3: Select the IP address which is not used and select **CONNECT** to assign which channel the live video should be displayed.

2.3 Power On

This device should be operated only with the type of power source indicated on the manufacturer's label. Connect the indicated AC power cord to the power adapter, and plug into an electrical outlet.

If your device has a power switch on the rear panel, turn it to "—". The power LED will be on. If your device doesn't have a power switch on its rear panel, the power is on once the power source is connected.

Note: Before the recorder is powered on, make sure (1) the cameras are connected and power-supplied for the detection of the camera video system to be correct, and (2) a monitor is connected to the recorder for correct video output detection.

Note: To ensure that your recorder works constantly and properly, it's recommended to use an UPS, Uninterruptible Power Supply (Optional), for continuously operation.

Note: When your recorder is powered on, please check the chapter of "3. FOR INITIAL USE" in the user manual to know how to configure this device and change the default user name and password. To download the user manual, please scan the QR code on the first page, or go to www.surveillance-download.com/user/z404.swf.

HD CCTV DVR

快速設定

■ 2MP ~ 5MP 錄影

在使用本機前請務必詳細閱讀安全須知及操作說明，並保存此手冊以供日後參考。

產品畫面顯示與操作請以實機為主。

完整使用手冊及免費電腦版 CMS 軟體 (CMS Lite)，請掃描右側 QR code 或造訪網站：
www.surveillance-download.com/user/z404.swf



EaZY NETWORKING 設定



EaZy Networking 是一種免費的 P2P 雲端服務，將本裝置自動連線到網路，即插即用。

本裝置一般透過 P2P 連接，僅較複雜的環境應用會透過中繼伺服器傳輸，如：大企業使用的私人 IP 網路。大多數裝置皆透過 P2P 連接；部分大型企業因網路環境較為複雜，故採中繼伺服器連結。在 P2P 的連結上沒有速度限制。若是透過中繼伺服器傳輸，傳輸流量最高可達 10FPS@512kbps。若想要有穩定的傳輸品質，建議您可以購買我們 1GB 或 7GB 的資費專案。(每一個裝置皆包含 2GB 的傳輸流量供您免費試用。)

您可在 OS / android 裝置上，透過軟體 EagleEyes 進行設定，或直接在電腦的 Internet Explorer 上操作。

註： 以下說明如何透過行動裝置軟體 **EagleEyes** 進行設定，相關 **IE** 設定辦法請查看完整版操作手冊。

在使用此功能之前，請先確認：

- 本裝置已連接到一台路由器，且該路由器可設定連線上網。
- 螢幕右上方的網路圖示為 ，不是 。
- 您的 iOS / Android 行動裝置已裝妥 EagleEyes。

在 iOS / Android 行動裝置使用 EagleEyes 進行設定

步驟 1: 按滑鼠右鍵顯示主目錄選單，然後選擇【網路設定】→【WAN】。將【網路類型】設為【DHCP】，然後確認螢幕右上角的網路圖示是否從  變成 。

進階選單	
攝影機設定	國際網路 電子郵件 DDNS 通訊協定 EaZy
偵測設定	網路類型 DHCP 
警示音設定	IP 位址 192.168.001.010
網路設定	閘道 192.168.001.254
顯示設定	網路遮罩 255.255.255.000
錄影設定	主要 DNS 8.8.8.8
外接裝置設定	次要 DNS 168.95.1.1
DCCS	埠 80
IVS 設定	可用網路位址 www.google.com
事件通知設定	
離開	MAC:00:0E:53:EC:A7:B4

步驟 2: 在同一個目錄選單內，改選【EaZy】。啟動 EaZy Networking，然後將畫面停在此處。稍後要掃描 QR Code 條碼會用到。

快速設定	
一般設定	啟動 EAZY NETWORKING 開啟
時間設定	
日光節約	000E532B8613
EaZy	
離開	

步驟 3: 開啟行動裝置的 EagleEyes，然後選擇通訊錄左上角的“...”。選擇 。

步驟 4: 在【雲端】區點選【登入】，並註冊一個【雲端服務】的帳號。若您已經有雲端帳號，請直接登入。

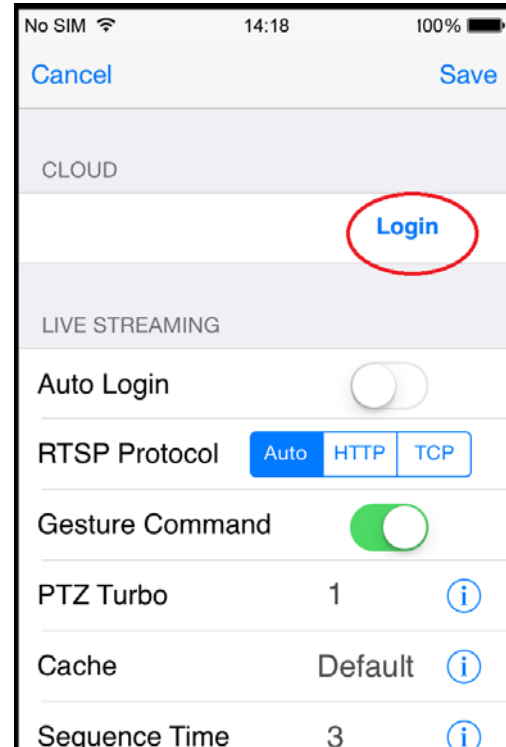
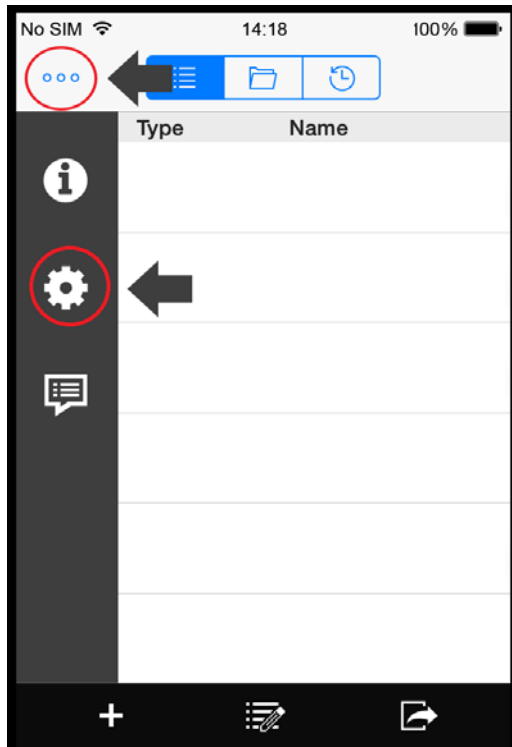

步驟 5: 回到通訊錄，然後點“+”新增裝置。

新增裝置有兩種方式：【EaZy 精靈】和【手動】。
選擇【EaZy 精靈】，然後選擇 DVR 圖示。

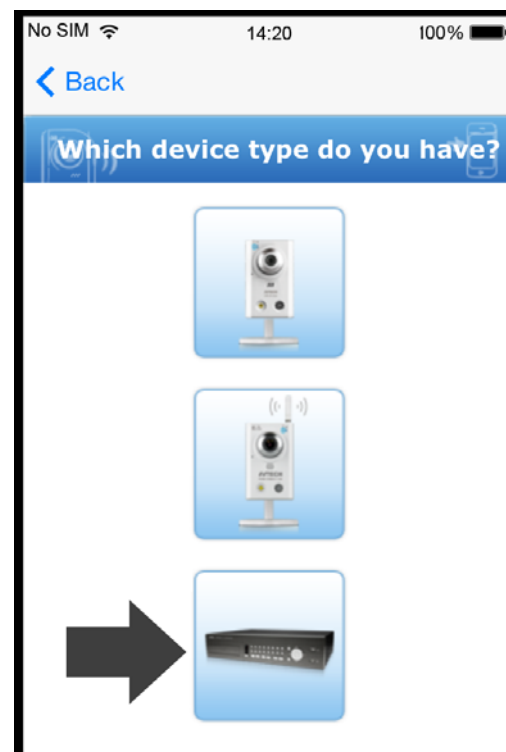
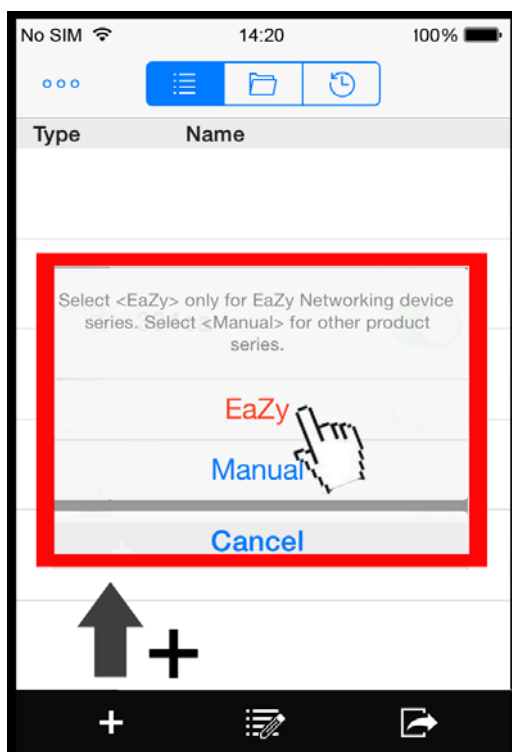

步驟 6: 在【MAC 序號】處點  開啟 QR Code 條碼掃描頁，然後掃描 DVR 畫面上的 QR Code 條碼。MAC 序號會自動填入。

手動輸入驗證碼，然後選【套用】。

步驟 7: 遵照螢幕指示完成設定，然後確認本裝置是否已成功加入 EagleEyes 通訊錄。

同時，EagleEyes 會提示您是否要刪除預設的使用者名稱和密碼。

- 若刪除預設的使用者名稱和密碼，在本機和遠端要登入本裝置時，就**只能**使用雲端服務的使用者名稱和密碼。若您不小心忘記了雲端服務的使用者名稱和密碼，就只能將本裝置回復原廠設定，然後再全部重新設定一次。
- 若選擇保留預設的使用者名稱和密碼，其他知道本裝置的預設使用者名稱和密碼的人就有機會偷偷登入本裝置。

請決定您是要保留或刪除預設的登入帳號，然後進行下一步。您會在 EagleEyes 通訊錄看到新加入的裝置，上面還有一朵雲的圖示，表示其為雲端裝置。

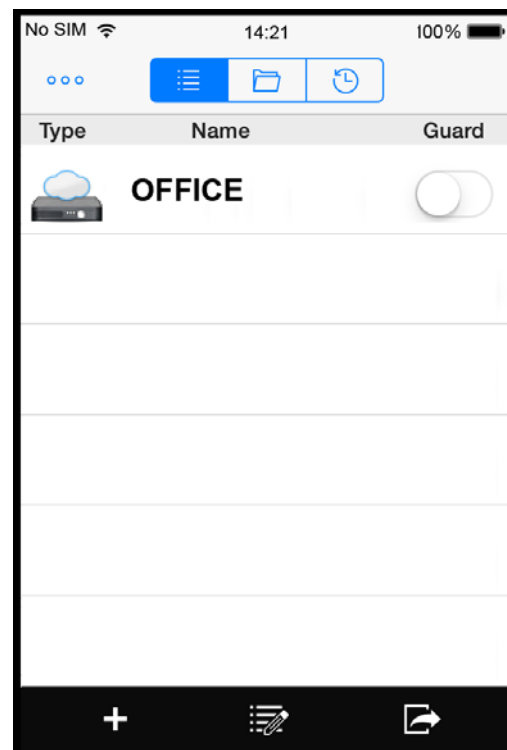

步驟 8: 點選新加入的裝置，確認是否可正常連線並看到畫面。

DVR 開機之前，請先確認是否已裝入硬碟，而且最少已接妥一隻攝影機和一台支援 HDMI 輸出的螢幕。詳情請參閱以下說明。

註：DVR 會自動偵測連接攝影機的影像系統 (NTSC 或 PAL)。為確保系統偵測無誤，在 DVR 開機之前，請先確定攝影機已接到 DVR 並上電。

2.1 安裝 SATA 硬碟

請至少在 DVR 安裝一顆硬碟，以利儲存錄影資料；而且，若在沒有安裝硬碟的情況下進行韌體更新，更新可能會失敗。

視您的 DVR 型號而定，請選擇適合的硬碟安裝方式。請從以下兩種方式，選擇適合您 DVR 的硬碟方式。

➤ 第一種方式

註：以下解說是以 8 路機種為硬碟安裝範例。如需得知您的 DVR 最多可安裝的硬碟數量，請參閱該 DVR 的規格。

步驟 1: 移除上蓋，然後找到硬碟連接埠和硬碟支架的位置。

步驟 2: 確認您的硬碟與本 DVR 相容。將硬碟的 PCB 面朝下，然後沿著其中一個硬碟支架插入硬碟。

註：若您的硬碟為綠能硬碟，請確認該顆硬碟為專為監控而設計的綠能硬碟；若不是，請勿使用該顆綠能硬碟，以確保本裝置使用正常。

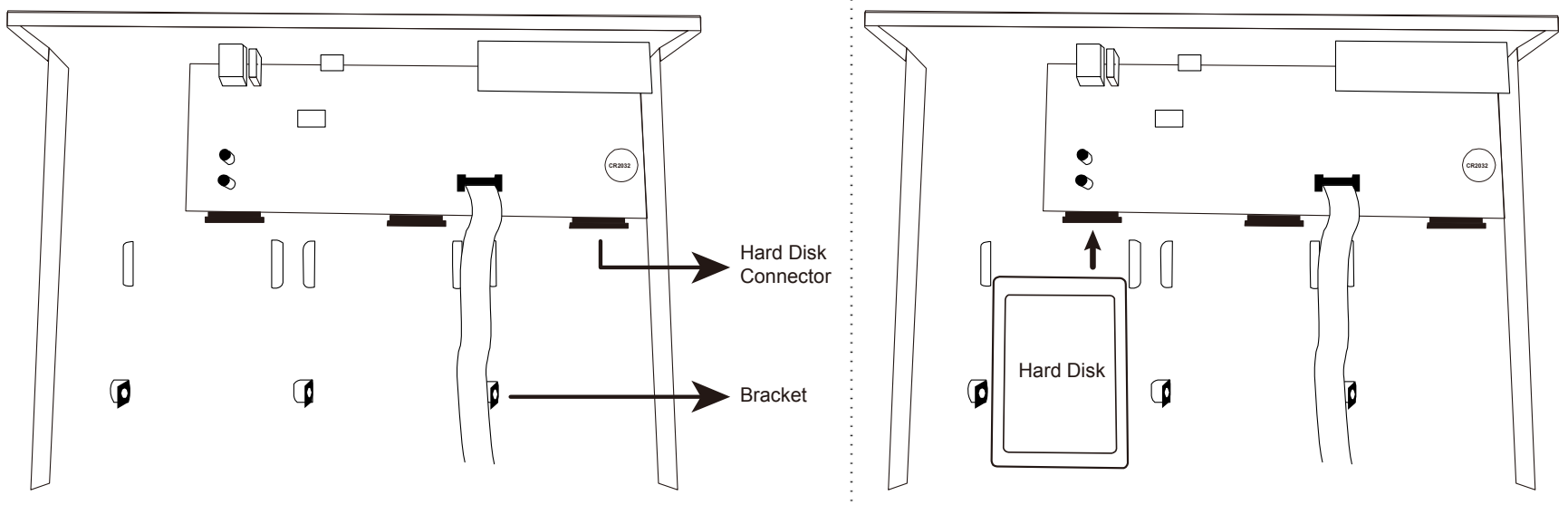

步驟 3: 將硬碟鎖在支架上固定住。

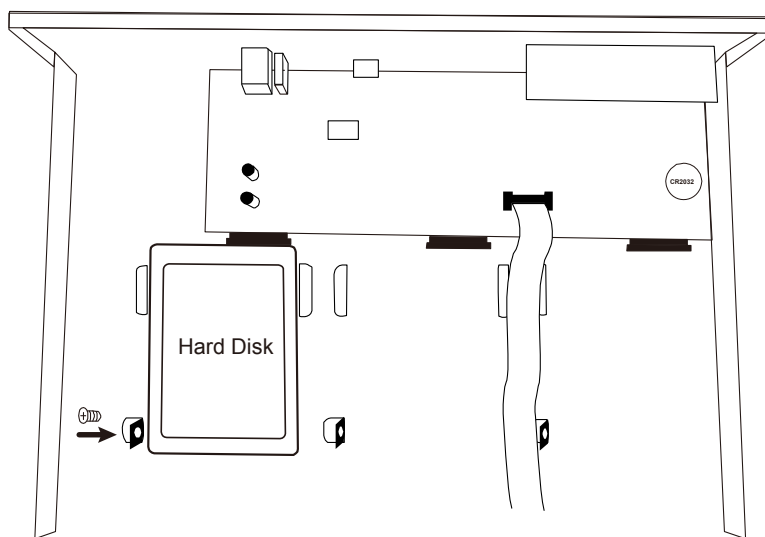

步驟 4: 裝回上蓋，然後鎖回在步驟 1 取下的螺絲。

➤ 第二種方式

註：以下解說是以 8 路機種為硬碟安裝範例。如需得知您的 DVR 安裝硬碟數量上限，請參閱該規格書。

步驟 1: 移除上蓋，然後找到安裝硬碟的位置。

步驟 2: 確認您的硬碟與本 DVR 相容。確認 DVR 底板的螺絲孔位置後，將硬碟的 PCB 面朝下，裝入硬碟。

註：若您的硬碟為綠能硬碟，請確認該顆硬碟為專為監控而設計的綠能硬碟；若不是，請勿使用該顆綠能硬碟，以確保本裝置使用正常。

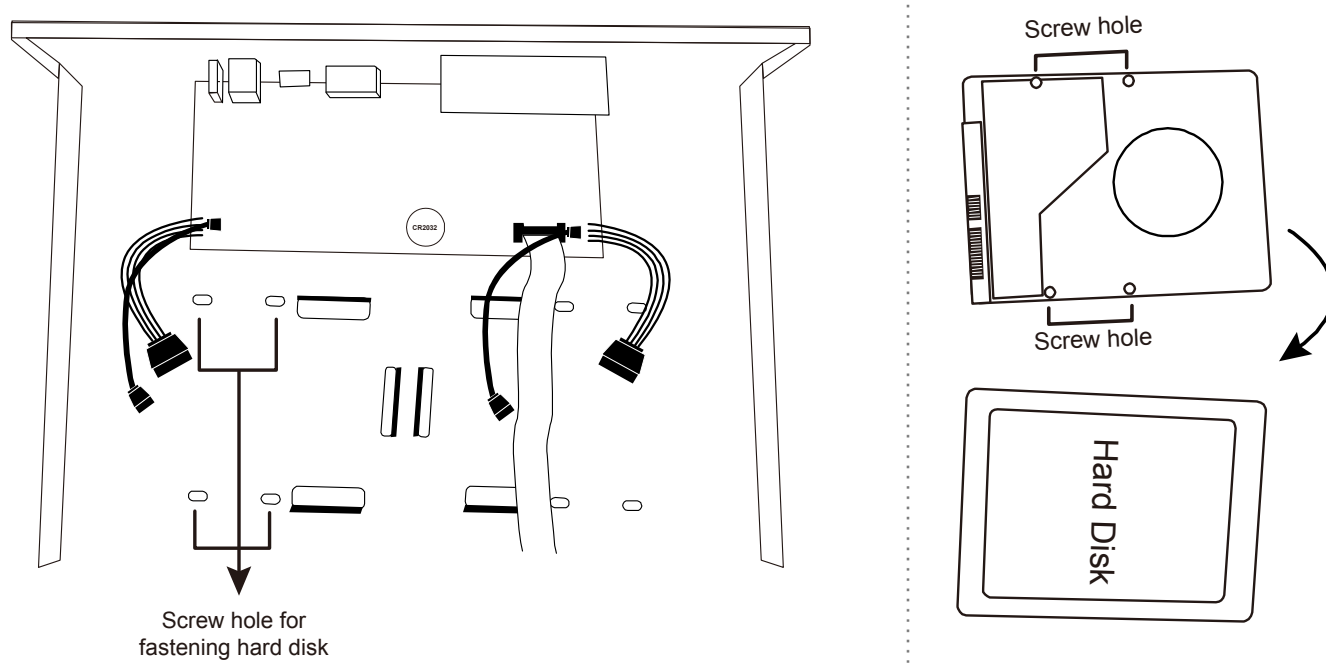

步驟 3: 將硬碟的螺絲孔對準 DVR 底板的螺絲孔。接著，從 DVR 底部將硬碟鎖在 DVR 底板，產品包裝內附有螺絲。

步驟 4: 連接硬碟的資料排線和電源線。

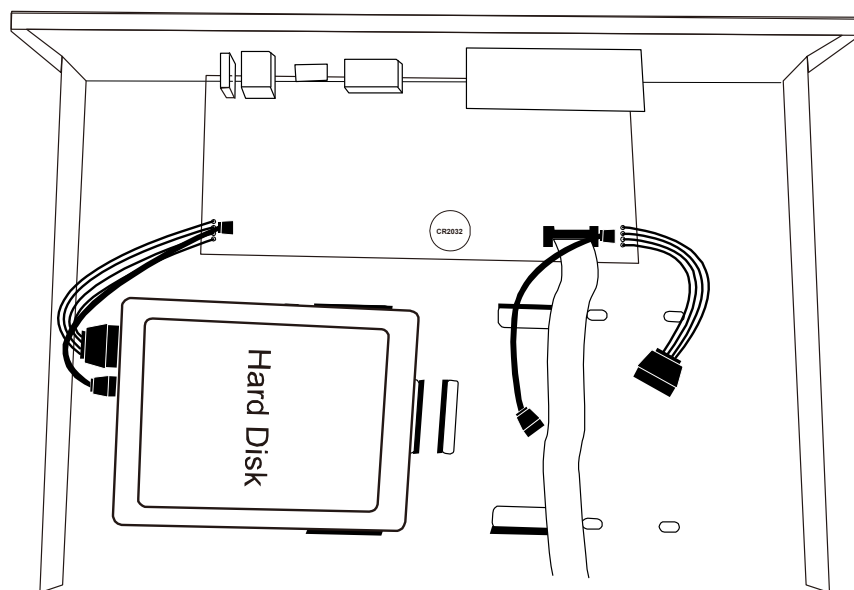

步驟 5: 裝回上蓋，然後鎖回在步驟 1 取下的螺絲。

2.2 攝影機連接

視您的安裝環境與攝影機種類而定，將攝影機安裝在天花板或牆壁上。如需得知安裝資訊，請參閱攝影機使用說明書。

2.2.1 一般攝影機

步驟 1: 用同軸電纜連接攝影機和 DVR。

步驟 2: (視機型而定) 將攝影機的音源埠和 DVR 的音源輸入埠用一條音源線接起來。

步驟 3: 依指定電源規格連接攝影機，並插入電源插座。確認是否可看到即時影像。

2.2.2 HD CCTV 攝影機系列

步驟 1: 用同軸電纜連接攝影機和 DVR。

步驟 2: 依指定電源規格連接攝影機，並插入電源插座。確認是否可看到即時影像。

步驟 3: 在 DVR 中，按滑鼠右鍵叫出主選單，前往【】(進階設定) → 【DCCS】 → 【OSD 選單】進行設定。

進階選單	
攝影機設定	CH1 CH2 CH3 CH4
偵測設定	OSD 選單 設定
警示音設定	
網路設定	
顯示設定	
錄影設定	
外接裝置設定	
DCCS	
IVS 設定	F.W. 1017
事件通知設定	裝置 AVT 系列
搖桿	連線設定 OK
離開	

2.2.3 他牌快速球攝影機

註: 錄影機需可用 **RS485** 線連接快速球攝影機，請查看錄影機使用手冊。

步驟 1: 用同軸電纜連接攝影機和 DVR。





步驟 2: 在 DVR 背板找到 RS485-A 及 RS485-B 連接埠，再按攝影機使用手冊指示連接至 DVR。將攝影機上電。

步驟 3: 在 DVR 中，按滑鼠右鍵叫出主選單，前往【】(進階設定) → 【外接裝置設定】，進行設定。

- a) 裝置 → 選【PTZ】。
- b) 將 ID 設定為跟攝影機相同。
- c) 將通訊協定設為【P-P】、【P-D】、【S-T】或【S-E】。

註: **Pelco** 使用 **P-P** 及 **P-D** 通訊協定。**Samsung** 使用 **S-T** 及 **S-E** 通訊協定。

- d) 將鮑率設定為跟攝影機相同。
- e) 介面設為【RS485】

進階選單	
攝影機設定	CH1 CH2 CH3 CH4
偵測設定	裝置 PTZ 
警示音設定	ID 000
網路設定	通訊協定 P-P 
顯示設定	鮑率 2400 
錄影設定	介面 RS485 
外接裝置設定	
DCCS	
IVS 設定	
事件通知設定	
搖桿	
離開	

2.2.4 IP 攝影機

註：請查看 **DVR** 規格，是否支援 **IP** 攝影機。

步驟 1: 將攝影機連接至 **DVR** 所使用的路由器，再開機。

步驟 2: 在 **DVR** 中，將游標移到左側，可見快速功能選單，按  (IP 搜尋) 尋找攝影機。

搜尋 IP 位置					
IP	埠	MAC	類型	通訊協定	狀態
10.1.1.12	88	00:0e:53:e5:9a:f1	IP 攝影機	AVTECH	未使用
10.1.1.12	88	UNKNOWN	IP 攝影機	ONVIF	未使用
			連線	設定	離開

步驟 3: 選未使用的 **IP** 位置，按【連線】，分配即時影像的播放頻道。

2.3 DVR 開機

請依 **DVR** 適用電源規格使用電源線。連接指定 **AC** 電源線與變壓器，插入插座。

若您使用的裝置背面有電源開關，請按至「—」，電源 **LED** 示意燈會亮起，表示開機。若無，上電後即會開機。

註：將開機前，請確保 (1) 攝影機連接妥當，攝影機影像系統的電源供應正常。(2) 已將螢幕連至 **DVR**，供影像輸出偵測。

註：建議使用 **UPS** (不斷電供應)，確保 **DVR** 功能運作順暢不中斷。

註：開啟後，請閱讀使用手冊第三章，了解如何設定裝置，及變更使用者帳號密碼。

完整使用手冊請至以下網站下載，或掃描本說明書第一頁的 **QR code**。

www.surveillance-download.com/user/z404.swf

HD-CCTV-DVR

STARTMENÜ

- **Videoaufnahmen mit Auflösung von 2 MP ~ 5 MP**

Bitte lesen Sie diese Anleitung sorgfältig durch und bewahren Sie sie für einen späteren Gebrauch auf. Bezüglich der tatsächlichen Bildschirmanzeigen und Bedienschritte orientieren Sie sich bitte an Ihrem DVR.

Die vollständige Bedienungsanleitung und kostenlose PC-CMS-Software (CMS Lite) erhalten Sie durch Scannen des QR-Codes auf der rechten Seite oder unter: www.surveillance-download.com/user/z404.swf.



EAZY NETWORKING EINRICHTEN



EaZy Networking ist ein kostenloser P2P-Cloud-Dienst, mit dem sich AVTECH-Geräte über Plug-and-Play automatisch mit dem Internet verbinden lassen, wodurch Sie sich die Live-Ansicht jederzeit an Ihrem Mobilgerät oder Notebook ansehen können (in 64 kb/s). Falls Sie den Eindruck haben, dass die Live-Ansicht nicht flüssig genug ist und Sie sie beschleunigen möchten, bietet AVTECH verschiedene Datenpläne, die Sie abonnieren können. Wir bieten zudem eine 2-GB-Datenerlaubnis als Schnupperangebot bei jedem Gerät. Wenn die 2 GB aufgebraucht sind, wird die Netzwerkübertragungsgeschwindigkeit auf den vorgesehenen Wert zurückgesetzt.

In den meisten Fällen wird das Gerät per P2P verbunden. Die Verbindung über den Relaisserver ist nur für einige komplexe Umgebungen, z. B. der privaten IP-basierten Netzwerkumgebung eines großen Unternehmens, verfügbar.

EaZy Networking kann an einem iOS-/Android-Gerät über EagleEyes oder über den Internet Explorer konfiguriert werden.



Hinweis: Die nachstehenden Anweisungen erläutern die Konfiguration über die kostenlose Mobil-App EagleEyes. Bitte beziehen Sie sich für die Konfiguration via Internet Explorer auf die gesamte Anleitung.

Achten Sie vor Verwendung dieser Funktion darauf, dass Folgendes zutrifft:

- Dieser DVR ist an einen Switch oder Router angeschlossen und der Switch oder Router kann mit dem Internet verbunden werden.
- Das Netzwerksymbol oben rechts zeigt , nicht .
- Sie haben ein iOS- / Android-Mobilgerät mit installiertem EagleEyes

Über EagleEyes auf einem iOS-/Android-Gerät

Schritt 1: Rechtsklicken Sie, um das Hauptmenü anzuzeigen, und wählen Sie dann **NETZWERK** → **WAN**.

Setzen Sie **NETZWERK-TYP** auf **DHCP** und vergewissern Sie sich, dass das Netzwerksymbol oben rechts sich von  auf  abändert.

ERWEITERTE EINSTELLUNG	
KAMERA ERKENNUNG ALARM NETZWERK DISPLAY AUFNAHME GERÄT DCCS IVS BENACHRICHTIGUNG JOYSTICK	WAN E-MAIL DDNS PROTOKOLL EaZy NETZWERK-TYP DHCP ▼ IP 192.168.001.010 GATEWAY 192.168.001.254 NETZMASKE 255.255.255.000 PRIMÄRE DNS 8.8.8.8 SEKUNDÄRE DNS 168.95.1.1 PORT 80 CHECK INTERNET AVAILABILITY BY ADDRESS www.google.com
VERLASSEN	MAC: 00:0E:53:EC:A7:B4

Schritt 2: Wählen Sie in demselben Menü die Option **EaZy**. Aktivieren Sie EaZy Networking und lassen Sie diese Seite geöffnet. Sie müssen später den QR-Code scannen.

STARTMENÜ	
GENERELL UHRZEIT SETUP SOMMERZEIT EaZy	ENABLE EAZY NETWORKING AN  000E532B8613
VERLASSEN	

Schritt 3: Öffnen Sie EagleEyes an Ihrem Mobilgerät und wählen Sie ... oben links im Adressbuch. Klicken Sie dann auf .

Schritt 4: Klicken Sie im Abschnitt **Cloud** auf **Anmelden** und registrieren Sie ein Konto für **Cloud-Dienst**. Haben Sie bereits ein Konto, müssen Sie sich nur anmelden.

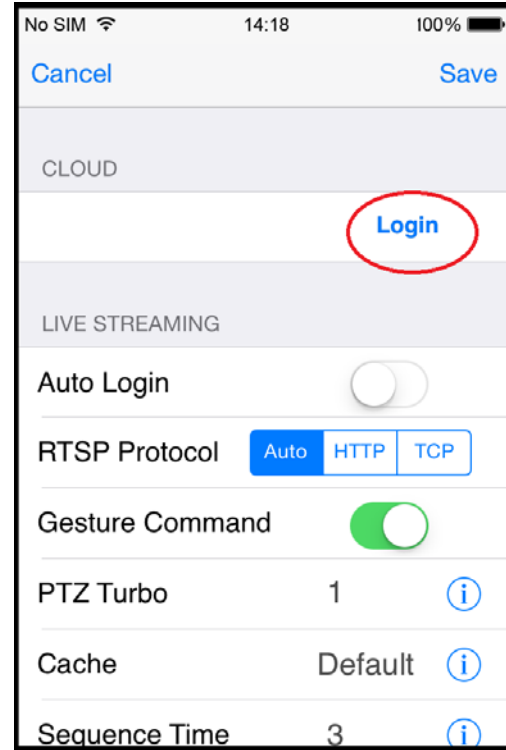
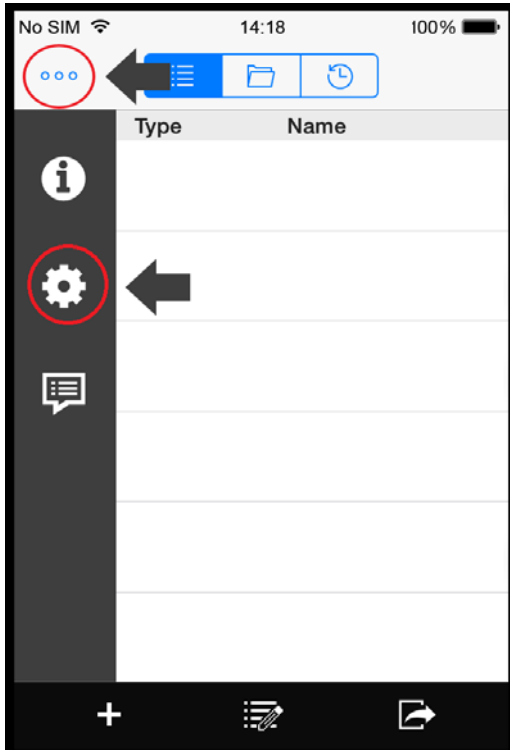

Schritt 5: Gehen Sie zurück zum Adressbuch und klicken Sie auf +, um ein neues Gerät hinzuzufügen. Zum Hinzufügen neuer Geräte gibt es die beiden Möglichkeiten **EaZy** und **Manuell**. Wählen Sie **EaZy** und dann das DVR-Symbol, um fortzufahren.

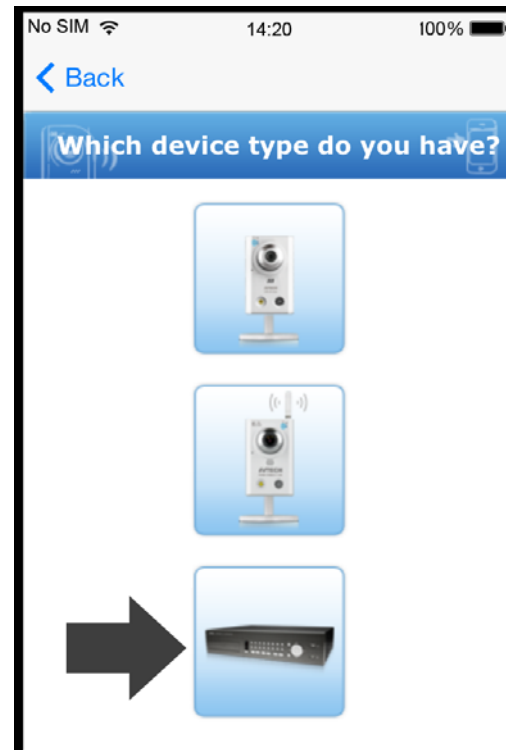
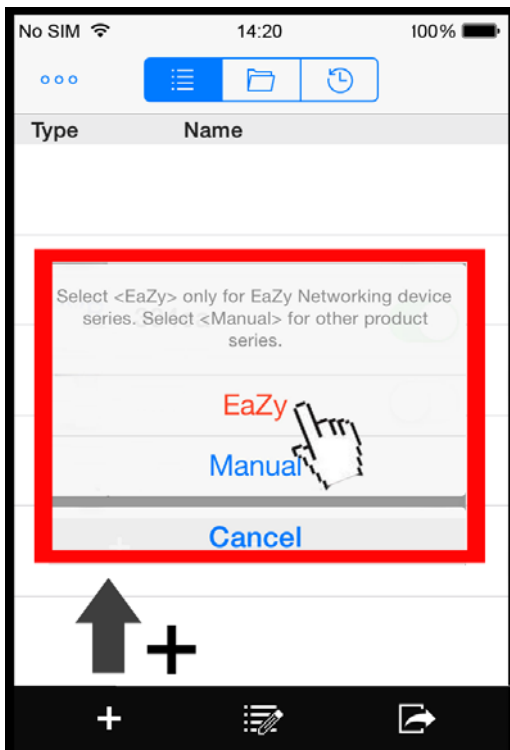

Schritt 6: Klicken Sie im Abschnitt **MAC-Adresse** auf , um die Seite zum Scannen des QR-Codes aufzurufen, und scannen Sie den QR-Code am DVR-Bildschirm, der in Schritt 2 erwähnt wurde. Die MAC-Adresse wird automatisch eingesetzt.

Tragen Sie den Captcha-Code manuell ein und klicken Sie auf **Anwenden**.

Schritt 7: Stellen Sie die restlichen Einstellungen anhand der Anweisungen am Bildschirm fertig und prüfen Sie, ob dieses Gerät dem Adressbuch erfolgreich als Cloud-Dienst hinzugefügt wurde.

Gleichzeitig werden Sie um die Bestätigung gebeten, den standardmäßigen Benutzernamen und das Passwort zu entfernen.

- Nach Entfernung des standardmäßigen Benutzernamens und des Passworts können Sie **NUR** mit dem Benutzernamen und dem Passwort des Cloud-Dienstes lokal und extern auf diesen Recorder zugreifen. Falls Sie den Benutzernamen und das Passwort des Cloud-Dienstes vergessen, können Sie den Recorder nur noch zurücksetzen und alle Konfigurationen nochmals durchlaufen.
- Werden der standardmäßige Benutzername und das Passwort beibehalten, können sich andere Personen Zugriff auf diesen Recorder verschaffen, wenn sie den standardmäßigen Benutzernamen und das Passwort dieses Recorders kennen.

Bestätigen Sie, ob Sie das Standardkonto für den weiteren Verlauf beibehalten möchten, und kehren Sie zum Adressbuch zurück. Das neu hinzugefügte Gerät ist im Adressbuch mit einem Cloud-Symbol gekennzeichnet.

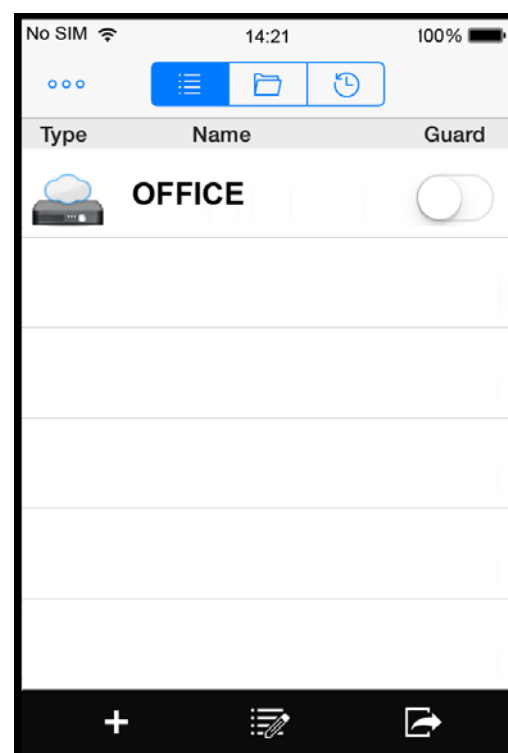

Schritt 8: Klicken Sie das neu hinzugefügte Gerät an und prüfen Sie, ob Sie erfolgreich darauf zugreifen können.

ANSCHLUSS UND EINRICHTUNG

Vor dem Einschalten des DVR muss gewährleistet sein, dass eine Festplatte installiert ist; außerdem müssen mindestens eine Kamera und ein HDMI-Monitor angeschlossen sein. Details hierzu finden Sie in den folgenden Abschnitten.

Hinweis: Der DVR kann das Videosystem der angeschlossenen Kameras automatisch erkennen (NTSC oder PAL). Um sicherzustellen, dass die Systemerkennung korrekt ist, prüfen Sie bitte, dass die Kameras an den DVR angeschlossen sind, mit Strom versorgt werden und der DVR eingeschaltet ist.

2.1 SATA-Festplatteninstallation

Es wird mindestens eine Festplatte benötigt, damit der Recorder Videomaterial speichern kann; zudem könnte die Firmwareaktualisierung fehlschlagen, wenn in diesem Recorder keine Festplatte installiert ist.

Bei Ihrem DVR-Modell trifft eine von beiden nachstehend aufgeführten Festplatteninstallationen zu. Ermitteln Sie bitte anhand der folgenden Anweisungen, welches der richtige Installationstyp für eine Festplatteninstallation bei Ihrem DVR ist.

➤ Typ 1

Hinweis: Hier dient ein 8-Kanal-Modell als Beispiel für den Anschluss einer Festplatte an Ihr Gerät. Die Anzahl der installierbaren Festplatten entnehmen Sie bitte den Spezifikationen Ihres Gerätes.

Schritt 1: Entfernen Sie die obere Abdeckung und lokalisieren Sie den Anschluss und die Halterung der Festplatte in Ihrem Gerät.

Schritt 2: Nehmen Sie eine kompatible Festplatte. Mit der Leiterplattenseite nach untenweisend, verbinden Sie die Festplatte mit einem der Festplattenanschlüsse.

Hinweis: Bei Verwendung einer umweltfreundlichen Festplatte nehmen Sie **NUR** eine Festplatte, die speziell für Überwachungszwecke vorgesehen ist, um einen störungsfreien Gerätebetrieb zu gewährleisten.

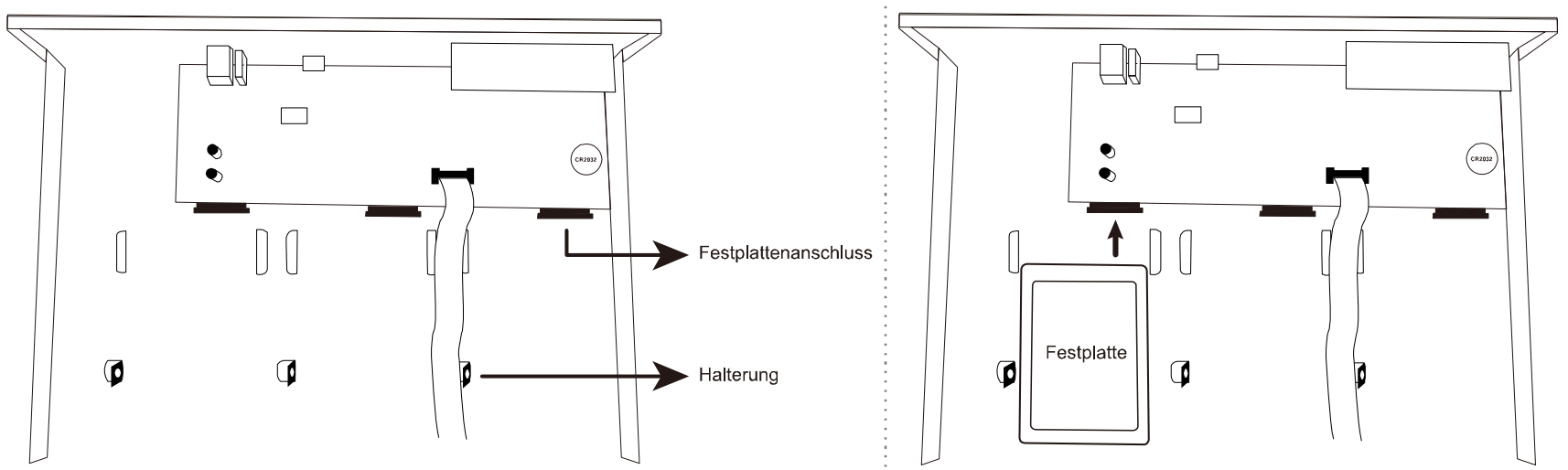

Schritt 3: Befestigen Sie die Festplatte mit Schrauben an der Halterung.

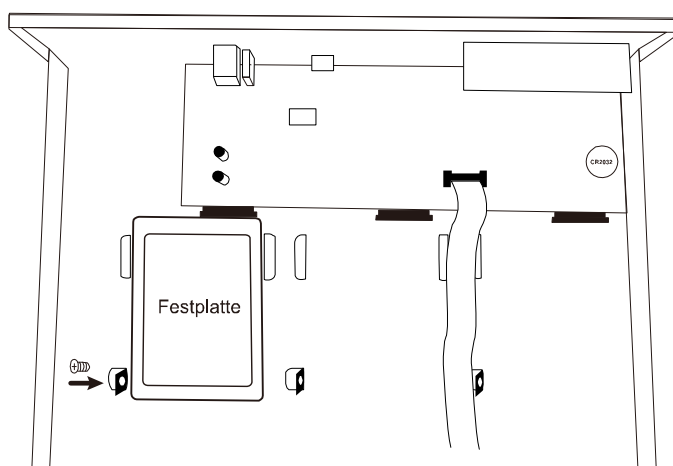

Schritt 4: Bringen Sie die obere Abdeckung wieder an und befestigen Sie die Schrauben, die Sie in Schritt 1 entfernt haben.

➤ Typ 2

Hinweis: Hier dient ein 8-Kanal-Modell als Beispiel für den Anschluss einer Festplatte an Ihr Gerät. Die Anzahl der installierbaren Festplatten entnehmen Sie bitte den Spezifikationen Ihres Gerätes.

Schritt 1: Entfernen Sie die obere Abdeckung und ermitteln Sie, wo eine Festplatte installiert wird.

Schritt 2: Nehmen Sie eine kompatible Festplatte. Mit der Leiterplattenseite nach unten weisend, lokalisieren Sie die Schraubenlöcher in der DVR-Basis; legen Sie die Festplatte in den DVR.

Hinweis: Bei Verwendung einer umweltfreundlichen Festplatte nehmen Sie **NUR** eine Festplatte, die speziell für Überwachungszwecke vorgesehen ist, um einen störungsfreien Gerätebetrieb zu gewährleisten.

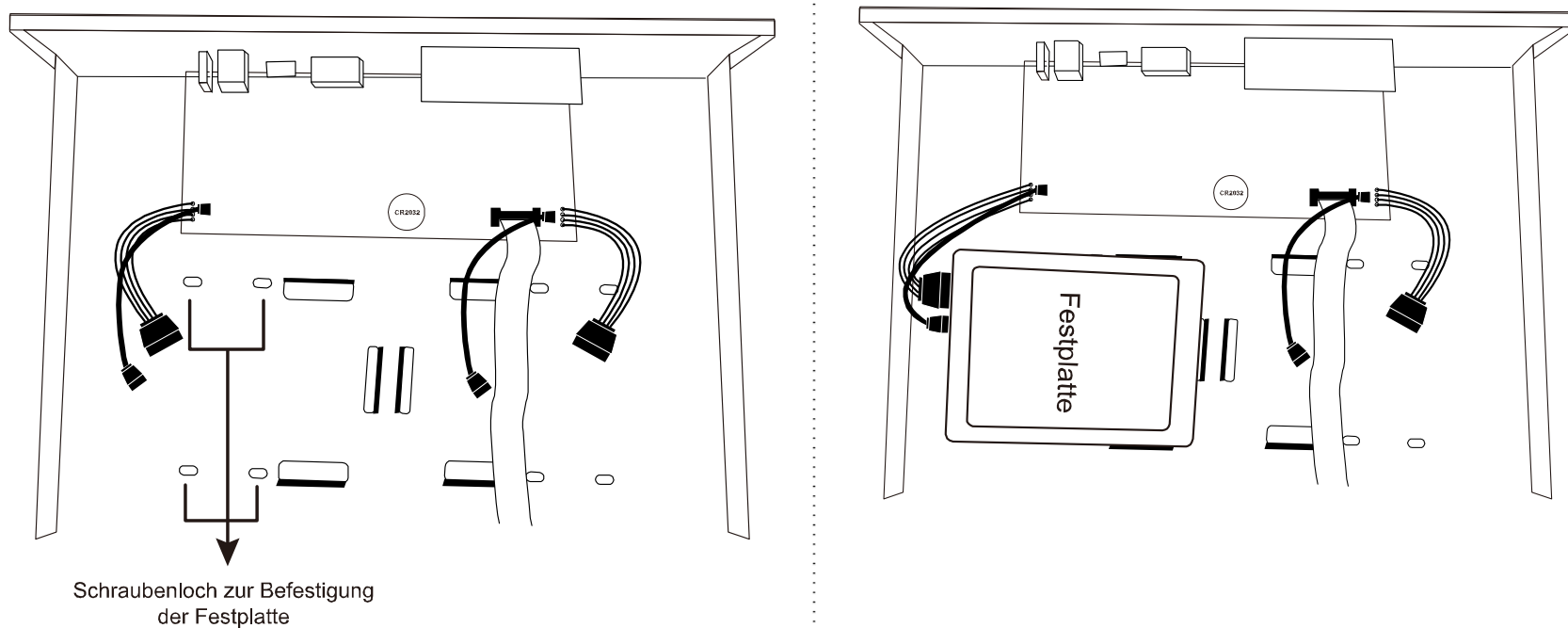

Schritt 3: Bringen Sie die Schraubenlöcher an DVR-Basis und Festplatte in Übereinstimmung. Befestigen Sie dann die Festplatte mit den mitgelieferten Schrauben über die Unterseite des DVR an der DVR-Basis.

Schritt 4: Schließen Sie das Datenbus- und das Stromversorgungskabel für die Festplatte an.

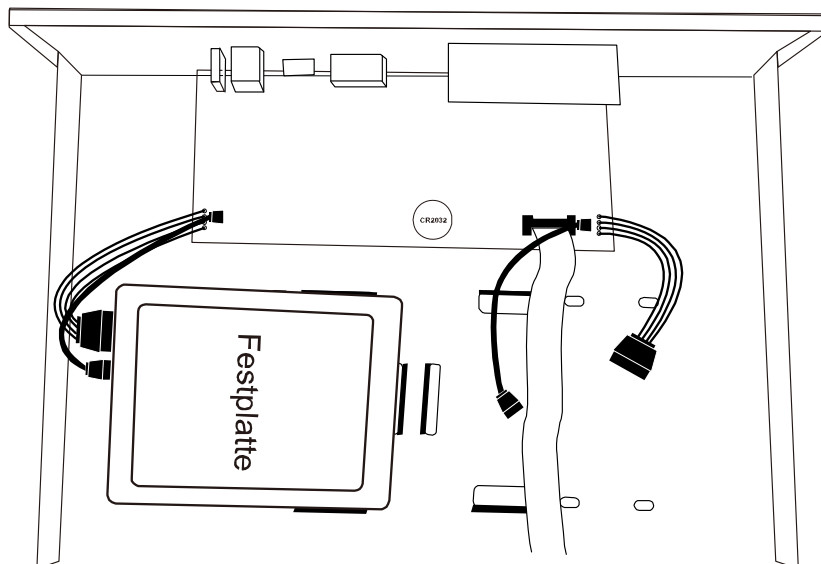

Schritt 5: Bringen Sie die obere Abdeckung wieder an und befestigen Sie die Schrauben, die Sie in Schritt 1 entfernt haben.

2.2 Kameraverbindung

Bringen Sie die Kamera je nach Ihrer Installationsumgebung und Kamerateyp an der Wand oder Decke an. Für Einzelheiten zur Installation beziehen Sie sich bitte auf die Bedienungsanleitung Ihrer Kamera.

2.2.1 Normale Kamera

SCHRITT 1: Schließen Sie das Koaxialkabel an den DVR an.

SCHRITT 2: (Optional) Schließen Sie das Audiokabel an den DVR an.

SCHRITT 3: Schalten Sie die Kamera ein und prüfen Sie, ob das Live-Video angezeigt wird.

2.2.2 Kameras der HD-CCTV-Serie

SCHRITT 1: Schließen Sie das Koaxialkabel an den DVR an.

SCHRITT 2: Schalten Sie die Kamera ein und prüfen Sie, ob das Live-Video angezeigt wird.









SCHRITT 3: Rufen Sie durch Rechtsklick auf der DVR-Seite das Hauptmenü auf und navigieren Sie zur Konfiguration der Kamera zu  (ERWEITERTE EINSTELLUNG) → **DCCS** → **OSD MENU**.

ERWEITERTE EINSTELLUNG	
KAMERA ERKENNUNG ALARM NETZWERK DISPLAY AUFNAHME GERÄT DCCS IVS BENACHRICHTIGUNG JOYSTICK VERLASSEN	CH1 CH2 CH3 CH4 OSD MENU SETUP DCCS MENU SETUP F.W. 1017 GERÄT AVT-Serie VERBINDUNG OK

Kameras der EZUM-Serie

Für von Ihnen verbundene Kameras aus unserer EZUM-Serie haben wir zudem eine Reihe von Symbolen zur schnellen Kameraeinrichtung entworfen. Basierend auf dem verbundenen EZUM-Kamerateyp finden Sie nachstehend einige Symbole zur schnellen Kamerakonfiguration aufgelistet und die Subfunktionen jedes Symbols können zudem je nach verbundener Kamera variieren.

Pfad: Unten links in jeder Kamerakanalansicht → .

	Tag und Nacht Konfigurieren Sie die Tag- und Nachtmodi der Kamera		IR-Management Passen Sie die Helligkeit der IR-LEDs manuell an.
	Rauschunterdrückung Reduzieren Sie die Rauschunterdrückung, falls erforderlich.		Optik Ändern Sie manuell die Verschlussgeschwindigkeit, falls erforderlich.
	Farbe Passen Sie farbrelevante Parameter manuell an, falls erforderlich.		Bilddoptimierung Verbessern Sie die Bildleistung für mehr Schärfe und Gesamtidentifikation, selbst in überbelichteten Bereichen.
	Zoom Wird bei Kameras mit motorisiertem Objektiv für optischen Zoom verwendet.		Heißer Punkt Klicken Sie auf den Bildschirm, um den Überwachungsbereich auf den gerade angeklickten Punkt zu schieben.
	PTZ-Steuerung Öffnen Sie die PTZ-Steuerung zum Schwenken, Neigen, Zoomen und Fahren der Kamera.		Erweitert Stellen Sie weitere Kameraparameter ein, z. B. Kamerasystem sowie Spiegelung bzw. Umkehrung von Kamerabildern.

2.2.3 Speed-Dome-Kamera einer anderen Marke

Hinweis: Der Recorder muss RS485-Konnektivität zur Verbindung einer Speed-Dome-Kamera unterstützen. Für weitere Einzelheiten prüfen Sie die bitte Spezifikationen Ihres Recorders.

SCHRITT 1: Schließen Sie das Koaxialkabel an den DVR an.

SCHRITT 2: Finden Sie die Anschlüsse RS485-A und RS485-B auf der Rückseite des DVR und folgen Sie den Anweisungen Ihrer Kameraanleitung, um eine Verbindung mit dem DVR herzustellen. Schalten Sie dann die Kamera ein.

SCHRITT 3: Rufen Sie durch Rechtsklick auf der DVR-Seite das Hauptmenü auf und navigieren Sie zu  (ERWEITERTE EINSTELLUNG) → **GERÄT**, um die Kamera einzustellen.

- a) Stellen Sie das Gerät auf **PTZ** ein.
- b) Stellen Sie die ID auf denselben Wert ein, der bei der Kamera eingestellt wurde.
- c) Stellen Sie das Protokoll auf **P-P**, **P-D**, **S-T** oder **S-E** ein.

Hinweis: **P-P** und **P-D** sind die von Pelco genutzten Protokolle, **S-T** und **S-E** sind die von Samsung genutzten Protokolle.

- d) Stellen Sie die Baudrate auf denselben Wert ein, der bei der Kamera eingestellt wurde.
- e) Stellen Sie die Schnittstelle auf **RS485** ein.

ERWEITERTE EINSTELLUNG																									
KAMERA ERKENNUNG ALARM NETZWERK DISPLAY AUFNAHME GERÄT DCCS IVS BENACHRICHTIGUNG JOYSTICK	<table style="width: 100%; border-collapse: collapse;"> <tr> <td style="text-align: center;">CH1</td> <td style="text-align: center;">CH2</td> <td style="text-align: center;">CH3</td> <td style="text-align: center;">CH4</td> </tr> <tr> <td>GERÄT</td> <td colspan="2">PTZ</td> <td style="text-align: right;">▼</td> </tr> <tr> <td>ID</td> <td colspan="3">000</td> </tr> <tr> <td>PROTOKOLL</td> <td colspan="2">P-P</td> <td style="text-align: right;">▼</td> </tr> <tr> <td>RATE</td> <td colspan="2">2400</td> <td style="text-align: right;">▼</td> </tr> <tr> <td>INTERFACE</td> <td colspan="2">RS485</td> <td style="text-align: right;">▼</td> </tr> </table>	CH1	CH2	CH3	CH4	GERÄT	PTZ		▼	ID	000			PROTOKOLL	P-P		▼	RATE	2400		▼	INTERFACE	RS485		▼
CH1	CH2	CH3	CH4																						
GERÄT	PTZ		▼																						
ID	000																								
PROTOKOLL	P-P		▼																						
RATE	2400		▼																						
INTERFACE	RS485		▼																						
<input type="button" value="VERLASSEN"/>																									

2.2.4 IP-Kamera

Hinweis: Prüfen Sie die technischen Daten Ihres DVR und klären Sie ab, ob der DVR eine IP-Kameraverbindung unterstützt.

SCHRITT 1: Verbinden Sie die Kamera mit demselben Switch / Router, mit dem auch der DVR verbunden ist, und schalten Sie die Kamera ein.

SCHRITT 2: Schieben Sie den Cursor auf der DVR-Seite zur Einblendung der Schnellleiste nach links und wählen Sie  (IP-Suche), um Ihre Kamera zu finden.

IP SUCHE									
IP	PORT	MAC	TYP	PROTOKOLL	STATUS				
10.1.1.12	88	00:0e:53:e5:9a:f1	IP KAMERA	AVTECH	UNBENUTZT				
10.1.1.12	88	UNBEKANNT	IP KAMERA	ONVIF	UNBENUTZT				
<table style="width: 100%; border-collapse: collapse;"> <tr> <td style="width: 40%;"><input type="button" value="t↓"/></td> <td style="width: 20%;"><input type="button" value="VERBINDUNG"/></td> <td style="width: 20%;"><input type="button" value="SETUP"/></td> <td style="width: 20%;"><input type="button" value="VERLASSEN"/></td> </tr> </table>						<input type="button" value="t↓"/>	<input type="button" value="VERBINDUNG"/>	<input type="button" value="SETUP"/>	<input type="button" value="VERLASSEN"/>
<input type="button" value="t↓"/>	<input type="button" value="VERBINDUNG"/>	<input type="button" value="SETUP"/>	<input type="button" value="VERLASSEN"/>						

SCHRITT 3: Wählen Sie eine nicht benutzte IP-Adresse und weisen Sie durch Wahl von **VERBINDUNG** zu, in welchem Kanal das Live-Video angezeigt werden soll.

2.3 Einschalten des DVR

Dieses Gerät darf nur mit der Stromquelle betrieben werden, die am Typenschild des Herstellers angegeben ist. Verbinden Sie das ausgewiesene Netzkabel mit dem Netzteil und stecken Sie den Netzstecker in eine Steckdose.

Befindet sich an der Rückseite Ihres Gerätes ein Ein/Aus-Schalter, setzen Sie ihn auf „—“. Die Betriebs-LED leuchtet jetzt. Gibt es an der Rückseite Ihres Gerätes keinen Ein/Aus-Schalter, wird es gleich nach dem Anschluss an eine Stromquelle mit Strom versorgt.

Hinweis: Achten Sie vor dem Einschalten des DVR darauf, dass (1) die Kameras angeschlossen sind und mit Strom versorgt werden, damit das Kameravideosystem richtig erkannt wird, und (2) ein Monitor an den DVR angeschlossen ist, damit die Videoausgabe richtig erkannt wird.

Hinweis: Um zu gewährleisten, dass Ihr DVR konstant und richtig funktioniert, wird eine USV, Unterbrechungsfreie Stromversorgung (Option), für den kontinuierlichen Betrieb empfohlen.

Hinweis: Wenn Ihr DVR eingeschaltet ist, lesen Sie bitte im Kapitel „3. BEI ERSTMALIGER VERWENDUNG“ in der Bedienungsanleitung nach, wie dieses Gerät konfiguriert wird und der Standardbenutzername sowie das Passwort geändert werden kann. Laden Sie die Bedienungsanleitung herunter, indem Sie den QR-Code auf der ersten Seite scannen oder www.surveillance-download.com/user/z404.swf aufrufen.

VIDEOREGISTRATORE HD

AVVIO RAPIDO

■ **Registrazione video 2MP ~ 5MP**

Leggere accuratamente le istruzioni prima dell'uso e conservarle per riferimenti futuri.
Fare riferimento al DVR impiegato per le schermate e le operazioni effettive Per scaricare la versione completa: www.surveillance-download.com/user/z404.swf.





EaZy Networking è un servizio cloud P2P gratuito per connettere dispositivi AVTECH automaticamente a Internet mediante plug-and-play, e consente di controllare i video live dal dispositivo mobile o laptop in qualsiasi momento (in 64 kbps). Se i video live non sono sufficientemente fluidi e si desidera velocizzarli, AVTECH offre diversi piani dati da sottoscrivere. Offriamo inoltre 2GB di data come regalo per ciascun dispositivo utilizzato. All'esaurimento dei 2 GB, la velocità di trasmissione della rete sarà ripristinata.

In molti casi, il dispositivo è connesso mediante P2P. La connessione mediante server relay è applicata solo ad alcuni ambienti complessi come un ambiente di rete basato su IP privato utilizzato da diverse aziende.



EaZy Networking può essere configurato tramite EagleEyes su un dispositivo iOS / Android o tramite Internet Explorer.

Prima di usare questa funzione, assicurarsi che:

- Il DVR sia collegato a uno switch o router, e che lo switch o router siano pronti per il collegamento a Internet.
- L'icona della rete nell'angolo superiore destro sia  e non .
- Si possiede un dispositivo mobile iOS/Android sul quale è installato EagleEyes.

Impostazione

Fase1: Fare clic col tasto destro del mouse per visualizzare il menu principale e selezionare RETE → "WAN".

Impostare il "TIPO RETE" su "DHCP" e assicurarsi che l'icona di rete nell'angolo superiore destro sia cambiata da  a .

Nota: Se l'impostazione è eseguita tramite l'Impostazione guidata, il tipo di rete sarà passato automaticamente su DHCP.

AVANZA NELLA CONFIG	
CAMERA	WAN E-MAIL DDNS PROTOCOLLO EaZy
RILEVAMENTO	TIPO RETE DHCP ▼
AVVISO	IP 192.168.001.010
RETE	GATEWAY 192.168.001.254
VISUALIZZA	NETMASK 255.255.255.000
REGISTRA	DNS PRIMARIO 8.8.8.8
REMOTO	DNS SECONDARIO 168.95.1.1
DCCS	PORTA 80
IVS	VERIFICA DISPONIBILITÀ INTERNET TRAMITE www.google.com
NOTIFICA	INDIRIZZO
JOYSTICK	ATTIVA UPNP SPENTO
USCITA	MAC: 00:0E:53:EC:A7:B4

Fase2: Nello stesso menu, selezionare "EaZy". Attivare EaZy Networking e lasciare la pagina aperta. Sarà necessario eseguire la scansione del codice QR in seguito.

AVVIO RAPIDO	
IMPOSTAZIONI	ATTIVA EAZY RETEING ACCESO
SETUP ORA	
LUCE DIURNA	
EaZy	
	000E532B8613
USCITA	

Fase3: Aprire EagleEyes sul dispositivo mobile e selezionare "... " nell'angolo superiore sinistro nella rubrica.

Quindi cliccare su "EaZy".

Fase4: Fare clic su "Accedi" e registrare un account per il "Servizio cloud". Se si dispone di un account, è sufficiente accedere.

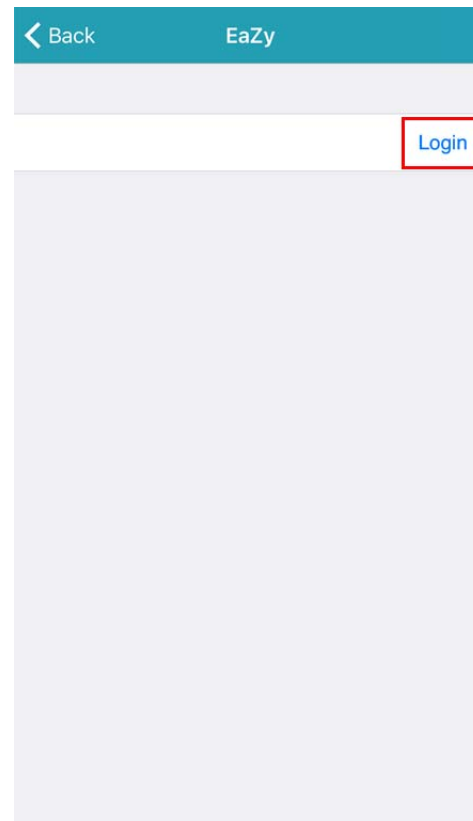
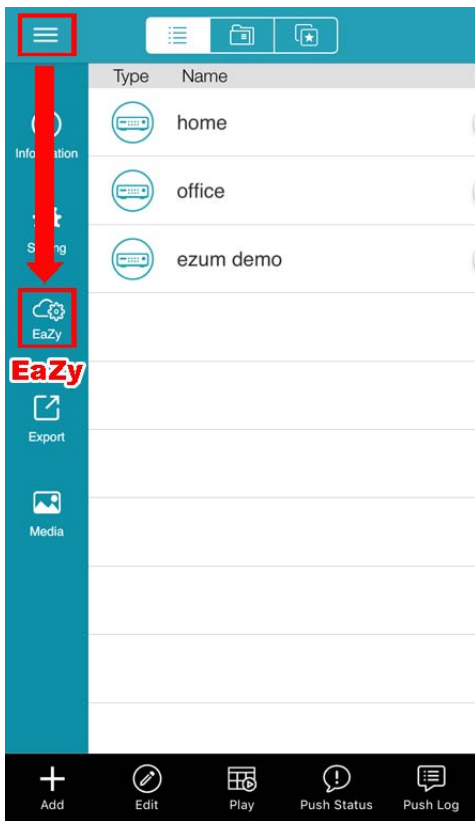

Fase5: Tornare alla rubrica e fare clic su "+" (Aggiungi) per aggiungere un nuovo dispositivo.

È possibile aggiungere nuovi dispositivi in due modi, "EaZy" e "Manuale".

Selezionare "EaZy" e scegliere l'icona registratore per continuare.

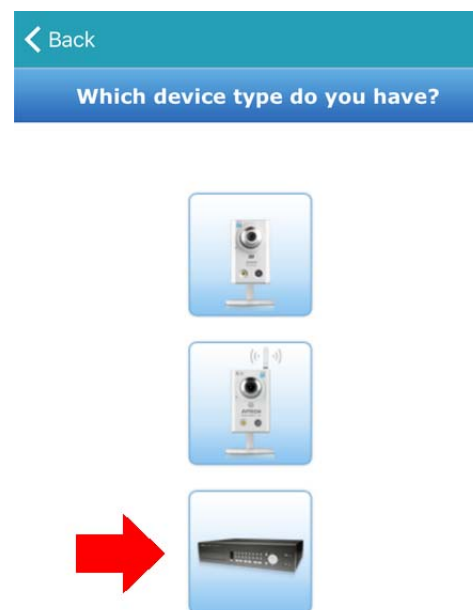
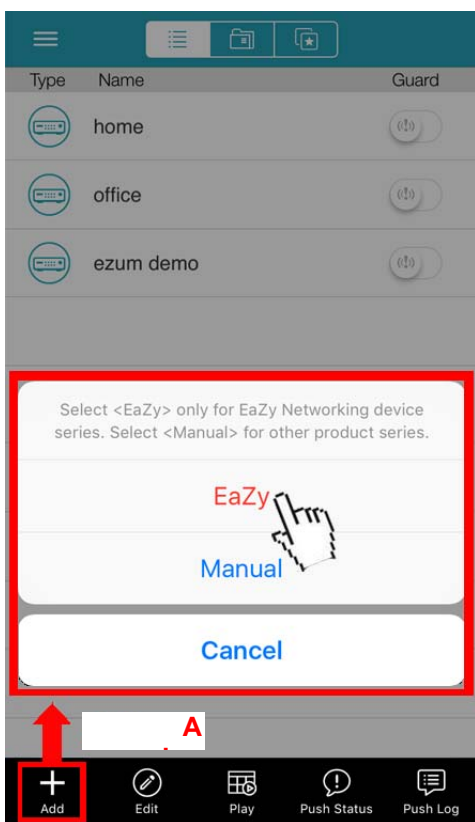

Fase6: Fare clic su  nella sezione "Indirizzo MAC" per aprire la pagina di scansione del codice QR e eseguire la scansione del codice QR sulla schermata del DVR citata nella Fase 2. L'indirizzo MAC sarà inserito automaticamente.

Inserire manualmente il codice Captcha e fare clic su "Applica".







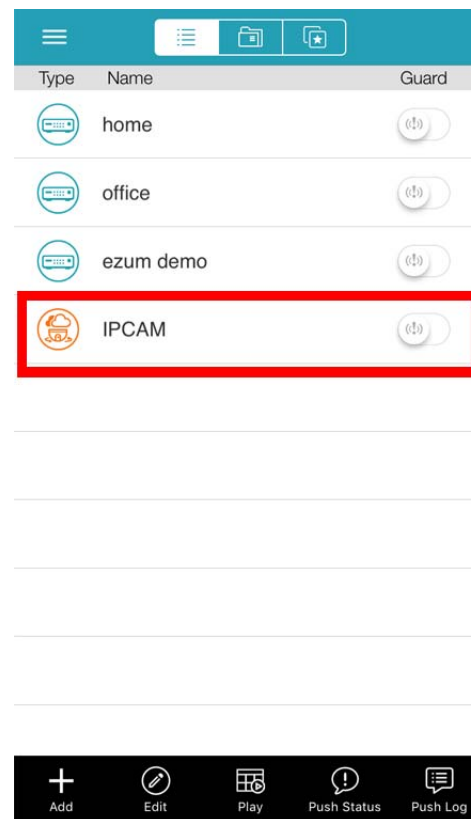

Fase7: Seguire le istruzioni su schermo per completare il resto delle impostazioni e vedere se il dispositivo viene aggiunto alla rubrica come dispositivo cloud.

Allo stesso tempo, sarà chiesto di confermare se si desidera rimuovere il nome utente e la password predefiniti.

- Quando vengono rimossi il nome utente e la password predefiniti, è possibile usare **SOLO** il nome utente e la password del servizio cloud per accedere al registratore localmente e da remoto. Se vengono dimenticati il nome utente e la password del servizio cloud, è possibile ripristinare il registratore e eseguire nuovamente tutte le configurazioni.
- Se vengono mantenuti il nome utente e la password predefiniti, altre persone potrebbero essere in grado di accedere al registratore se conoscono il nome utente e la password predefiniti del registratore.

Confermare che si desidera conservare l'account predefinito per continuare e tornare alla rubrica. Tra gli indirizzi sarà visualizzato il nuovo dispositivo aggiunto con accanto l'icona cloud.



Type	Name	Guard
	home	
	office	
	ezum demo	
	IPCAM	

Fase8: Fare clic sul nuovo dispositivo aggiunto e vedere se riesce a ad accedere al could.

COLLEGAMENTI E CONFIGURAZIONE

Prima di accendere il DVR, assicurarsi di avere installato il disco rigido e di avere collegato almeno una telecamera. Fare riferimento alle sezioni che seguono per i dettagli.

Note: Il DVR è progettato per rilevare automaticamente il sistema video delle telecamere collegate (NTSC o PAL). Per accertarsi che il rilevamento del sistema sia corretto, controllare che le telecamere siano collegate al DVR e che siano alimentate prima di accendere il DVR.

2.1 Disco SATA Installazione

È necessario almeno un disco rigido per consentire al registratore di salvare i filmati, inoltre potrebbe non essere possibile eseguire l'aggiornamento firmware se nel registratore non sono installati dischi rigidi.

Per questo modello di DVR è possibile installare il disco rigido in due modi. Consultare le istruzioni di seguito per vedere quale metodo di installazione è più adatto per l'installazione del disco rigido nel DVR.

➤ Typo 1

Note: Nel seguente esempio è considerato un modello a 8 canali per l'installazione di un disco rigido nel dispositivo. Per conoscere il numero di dischi rigidi che è possibile installare, consultare le specifiche del dispositivo.

Fase1: Rimuovere il coperchio superiore e trovare il connettore del disco rigido e il sostegno all'interno dell'unità.

Fase2: Prendere un disco rigido compatibile. Con il lato PCB rivolto verso il basso, inserire il disco rigido su uno dei connettori disco rigido.

Note: Per usare un disco rigido ecologico, usare SOLO dischi rigidi studiati appositamente per la sorveglianza per garantire il corretto funzionamento del dispositivo.

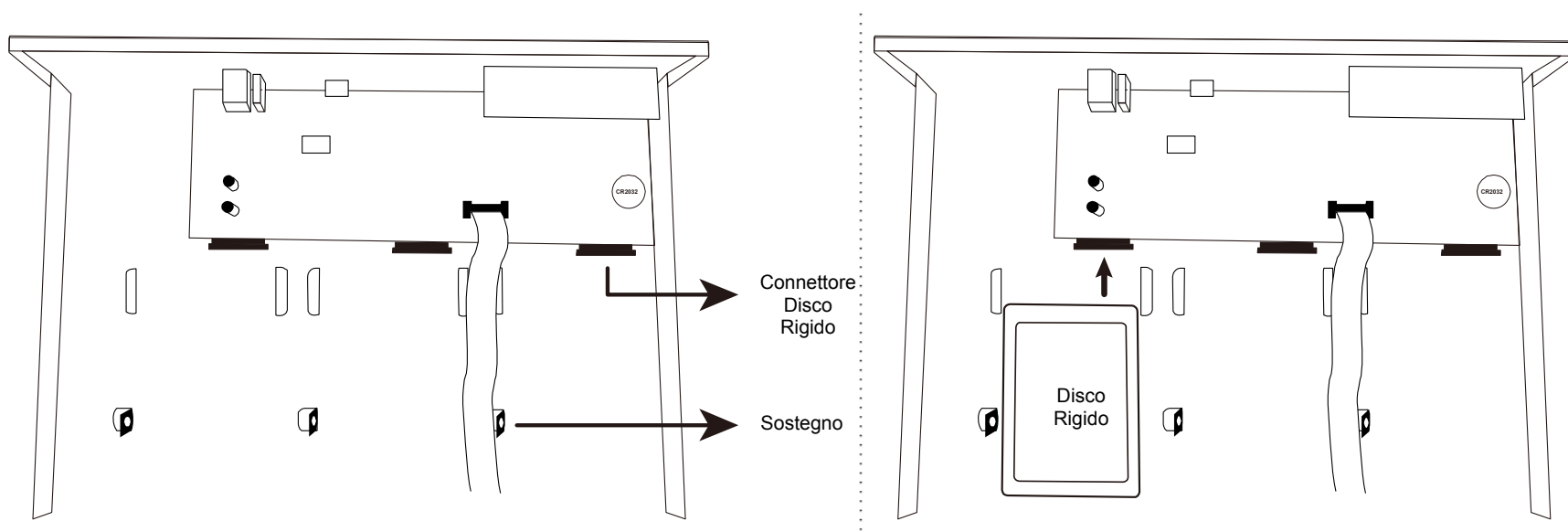

Fase3: Fissare il disco rigido al supporto stringendo la vite al supporto.

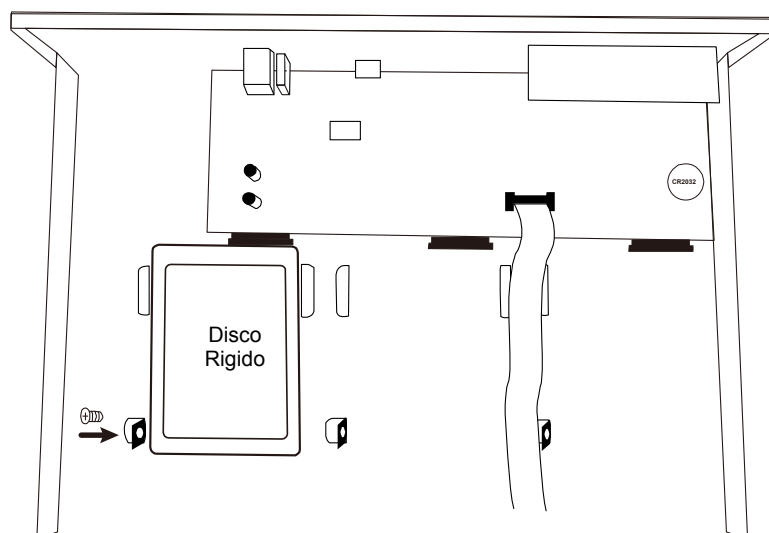

Fase4: Riposizionare il coperchio superiore e serrare le viti allentate nella Fase 1.

➤ Typo 2

Note: Nel seguente esempio è considerato un modello a 8 canali per l'installazione di un disco rigido nel dispositivo. Per conoscere il numero di dischi rigidi che è possibile installare, consultare le specifiche del dispositivo.

Fase1: Rimuovere il coperchio superiore e trovare dove installare il disco rigido.

Fase2: Prendere un disco rigido compatibile. Con il lato PCB rivolto verso il basso, trovare i fori delle viti sulla base del DVR e posizionare il disco rigido nel DVR.

Note: Per usare un disco rigido ecologico, usare SOLO dischi rigidi studiati appositamente per la sorveglianza per garantire il corretto funzionamento del dispositivo.

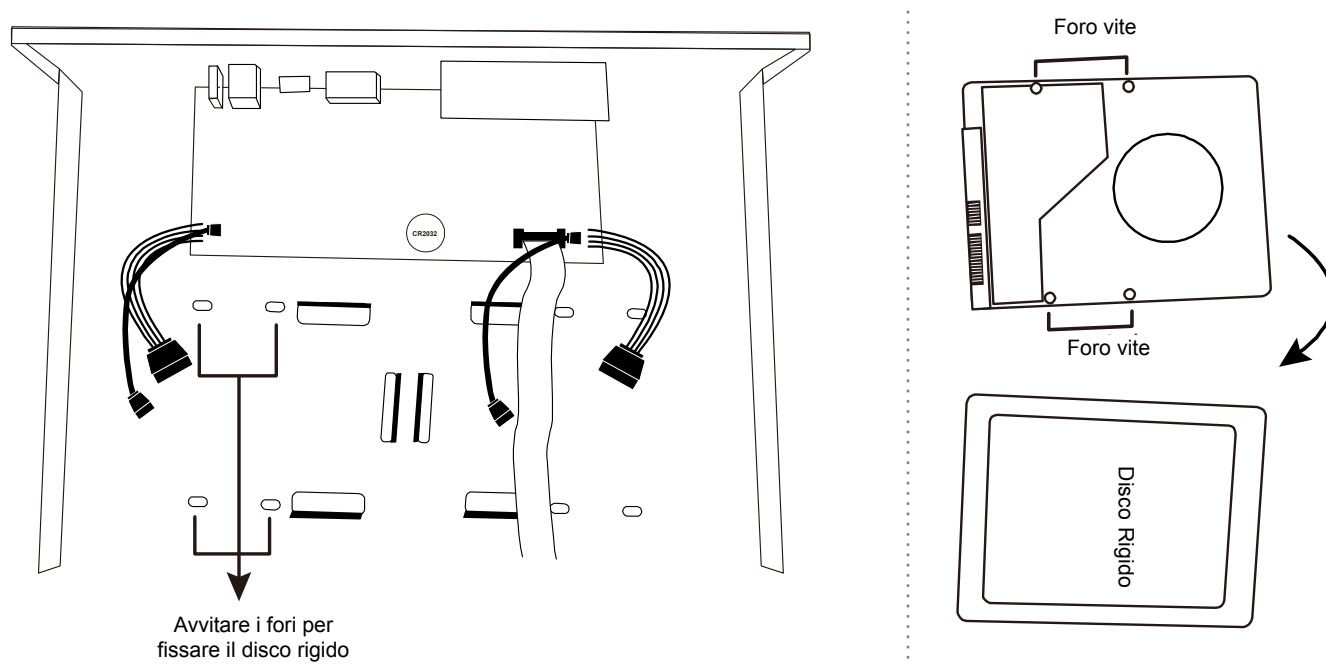

Fase3: Allineare i fori delle viti sulla base del DVR e sul disco rigido. Quindi fissare il disco rigido alla base del DVR mediante le viti in dotazione dal lato inferiore del DVR.

Fase4: Collegare il bus dati e il cavo di alimentazione del disco rigido.

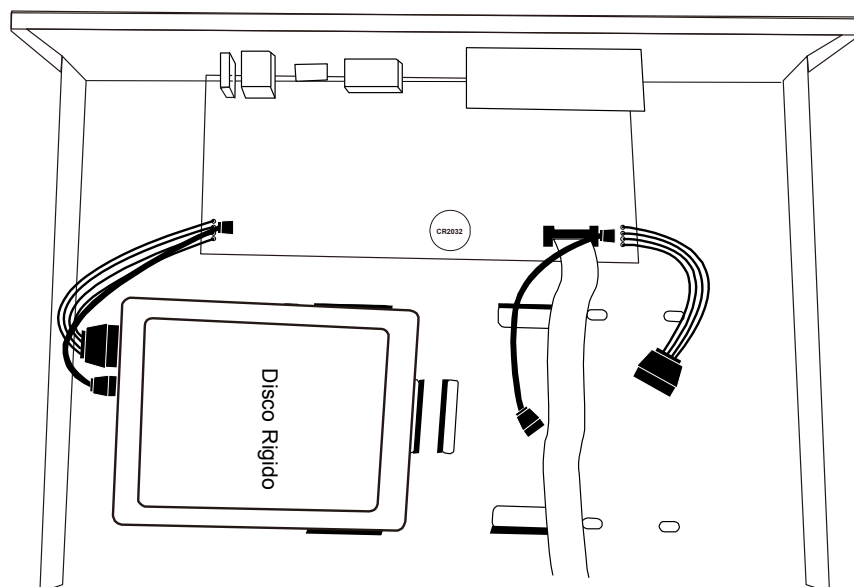

Fase5: Riposizionare il coperchio superiore e serrare le viti allentate nella Fase1.

2.2 Collegamento telecamera

Installare la telecamera a parete o sul soffitto, in funzione dell'ambiente di installazione e del tipo di telecamera. Per informazioni sull'installazione, fare riferimento al manuale utente della telecamera.

2.2.1 Telecamere Normali

FASE 1: Collegare il cavo coassiale al DVR.

FASE 2: (Opzionale) Collegare il cavo audio al DVR.

FASE 3: Alimentare la telecamera e verificare che il video appaia sullo schermo.

2.2.2 Telecamere HD CCTV

FASE 1: Collegare il cavo coassiale al DVR.

FASE 2: Alimentare la telecamera e verificare che il video appaia sullo schermo.

FASE 3: Sul DVR, fare clic con il tasto destro per visualizzare il menu principale, quindi andare su  (AVANZA NELLA CONFIG) → **DCCS** → **MENU OSD** per configurare la telecamera, se necessario.

AVANZA NELLA CONFIG			
CAMERA	CH1	CH2	CH3
RILEVAMENTO	MENU OSD		IMPOSTA
AVVISO	MENU DCCS		IMPOSTA
RETE			
VISUALIZZA			
REGISTRA			
REMOTO			
DCCS			
IVS	F.W.		1017
NOTIFICA	DISPOSITIVO		AVT Series
JOYSTICK	CONNESSIONE		OK
USCITA			

Serie di Telecamere EZUM

Se le telecamere collegate sono della nostra serie EZUM, abbiamo sviluppato anche una serie di icone per la configurazione rapida della telecamera. In base al tipo di telecamera EZUM collegato, possono essere disponibili alcune delle icone elencate di seguito per la configurazione rapida della telecamera, mentre le funzioni secondarie di ciascuna icona possono variare in base alla telecamera collegata.

Percorso: In basso a sinistra nella vista canale di ciascuna telecamera → .

	Giorno e Notte Per configurare le modalità giorno e notte della telecamera.		Gestione IR Per gestire manualmente la luminosità dei LED IR.
	Riduzione rumore Per ridurre il rumore nell'immagine, se necessario.		Ottiche Per cambiare manualmente la velocità dell'otturatore, se necessario.
	Colore Per regolare manualmente i parametri relativi al colore, se necessario.		Miglioramento immagine Per migliorare le prestazioni dell'immagine per una nitidezza migliore e l'identificazione globale anche in aree sovraesposte.
	Zoom Utilizzato con le telecamere a obiettivo motorizzato per lo zoom ottico.		Punto caldo Fare clic sullo schermo per spostare l'area di sorveglianza sul punto sui cui è appena stato fatto clic.
	Controllo PTZ Per aprire il pannello per il controllo PTZ per eseguire la panoramica, inclinazione, zoom e spostare la telecamera.		Avanzate Per impostare altri parametri della telecamera come ad esempio il sistema telecamere, riflessione o capovolgimento delle immagini della telecamera.

2.2.3 Telecamera speed dome di altri marchi

Note: Il registratore deve supportare la connessione RS485 per connettere una telecamera speed dome. Controllare le specifiche del registratore per i dettagli.

FASE 1: Collegare il cavo coassiale al DVR.

FASE 2: Individuare la posizione dei connettori RS485-A e RS485-B sul pannello posteriore del DVR, quindi seguire le istruzioni nel manuale della telecamera per il collegamento al DVR. Quindi accendere la telecamera.

FASE 3: Sul DVR, fare clic con il tasto destro per visualizzare il menu principale, quindi andare su  (AVANZA NELLA CONFIG) → **DISPOSITIVI** per impostare la telecamera.

- a) Selezionare **PTZ**.
- b) Impostare lo stesso valore ID impostato nella telecamera speed dome.
- c) Selezionare il protocollo su **P-P**, **P-D**, **S-T** o **S-E**.

Note: **P-P** e **P-D** sono i protocolli utilizzati da Pelco, mentre **S-T** e **S-E** sono i protocolli utilizzati da Samsung.

- d) Impostare la velocità in baud sullo stesso valore impostato per la telecamera speed dome.
- e) Impostare l'interfaccia su **RS485**.

AVANZA NELLA CONFIG				
CAMERA	CH1	CH2	CH3	CH4
RILEVAMENTO	DISPOSITIVO		PTZ	▼
cAVVISO	ID		000	
RETE	PROTOCOLLO		P-P	▼
VISUALIZZA	VELOCITÀ		2400	▼
REGISTRA	INTERFACCIA		RS485	▼
REMOTO				
DCCS				
IVS				
NOTIFICA				
JOYSTICK				
USCITA				

2.2.4 Telecamere IP di altre marche

Nota: Controllare le specifiche del DVR e vedere se il DVR supporta la connessione di telecamere IP.

FASE 1: Collegare la telecamera allo stesso switch / router su cui è collegato il DVR, quindi accendere la telecamera.

FASE 2: Sul DVR, spostare il cursore verso sinistra per visualizzare la barra rapida e scegliere  (Ricerca IP) per trovare la telecamera.

RICERCA IP									
IP	PORTA	MAC	TIPO	PROTOCOLLO	STATO				
10.1.1.12	88	00:0e:53:e5:9a:f1	TELECAMERA IP	AVTECH	DISUSO				
10.1.1.12	88	SCONOSCIUTO	TELECAMERA IP	ONVIF	DISUSO				
<table border="1" style="width: 100%; border-collapse: collapse;"> <tr> <td style="width: 50%; text-align: left;">t1</td> <td style="width: 20%; text-align: center;">CONNESS.</td> <td style="width: 20%; text-align: center;">IMPOSTA</td> <td style="width: 10%; text-align: center;">USCITA</td> </tr> </table>						t1	CONNESS.	IMPOSTA	USCITA
t1	CONNESS.	IMPOSTA	USCITA						

FASE 3: Selezionare l'indirizzo IP non utilizzato e selezionare **CONNESS** per assegnare il canale dove sarà visualizzato il video live.

2.3 Accensione DVR

Questo dispositivo deve essere fatto funzionare solamente con il tipo di alimentazione indicata sull'etichetta del produttore. Collegare il cavo d'alimentazione CA all'adattatore di corrente e ad una presa di corrente.

Se il dispositivo dispone di un interruttore di alimentazione sul pannello posteriore, spostarlo su "—". Il LED d'alimentazione si accenderà. Se il dispositivo non dispone di un interruttore di alimentazione sul pannello posteriore, si accede una volta collegata una sorgente di alimentazione.

Note: Prima di accendere il DVR, controllare (1) che le telecamere siano collegate e alimentate per il rilevamento corretto del sistema video delle telecamere, e (2) che un monitor sia collegato al DVR per il rilevamento corretto dell'uscita video.

Note: Per garantire che il DVR funzioni in modo costante ed appropriato, si raccomanda di usare un gruppo di continuità UPS (Uninterruptible Power Supply) - opzionale

Note: When your DVR is powered on, please check the chapter of "3. FOR INITIAL USE" in the user manual to know how to configure this device and change the default user name and password. To download the user manual, please scan the QR code on the first page, or go to www.surveillance-download.com/user/z404.swf.

DVR HD CCTV

Inicialización rápida

■ Grabación 2MP ~ 5MP

Please read instructions thoroughly before operation and retain it for future reference. For the actual display & operation, please refer to your DVR in hand.

To get the complete user manual and free PC CMS Software (CMS Lite), scan the QR code on the right, or go to the site:

www.surveillance-download.com/user/z404.swf.



CONFIGURACION EAZY NETWORKING



EaZy Networking o Red Fácil es un servicio gratuito de nube P2P que conecta aparatos de AVTECH con el internet de forma automática a través de conexión y reproducción (plug-and-play), permitiendo la vista en vivo a través de tu celular o laptop en cualquier momento (en 64 kbps). Si sientes que la vista en vivo no es tan rápida o fluida y te gustaría mejorarla, AVTECH provee diferentes planes de datos a los cuales te puedes suscribir. También, de entrada ofrecemos 2GB de datos gratis en cada equipo. Una vez que se hayan agotado los 2GB la velocidad de transmission volverá a la velocidad inicial.

En la mayoría de los casos, el equipo está conectado vía P2P. La conexión a través del relay del servidor solamente se aplica en ambientes complejos como entornos de red basados en IP privados que usualmente se usan en grandes empresas.



EaZy Networking se puede configurar a través de EagleEyes en equipos iOS / android, o vía Internet Explorer.

Nota: Las instrucciones a continuación explican cómo configurar a través de la aplicación gratuita, EagleEyes. Para saber cómo hacer la configuración por Internet Explorer, revisar el manual completo.

Antes de usar esta función, asegúrese de:

- Este DVR está conectado a un switch o router, y estos están listos para conexión a Internet.
- El ícono de red en la esquina superior derecha es , y no .
- Tiene un equipo iOS / Android con la aplicación EagleEyes instalada.

Vía EagleEyes en equipos iOS / Android

Paso1: Click derecho para mostrar el menú principal, y seleccionar **NETWORK** → **WAN**. Dejar **NETWORK TYPE** en **DHCP**, y asegurarse que el ícono de red en la esquina superior derecha ha cambiado de  a .

ADVANCED CONFIG	
CAMERA DETECTION ALERT	WAN E-MAIL DDNS PROTOCOL EaZy
NETWORK	NETWORK TYPE DHCP ▼
DISPLAY	IP 192.168.001.010
RECORD	GATEWAY 192.168.001.254
DEVICES	NETMASK 255.255.255.000
DCCS	PRIMARY DNS 8.8.8.8
IVS	SECONDARY DNS 168.95.1.1
NOTIFY	PORT 80
JOYSTICK	CHECK INTERNET AVAILABILITY BY ADDRESS www.google.com
EXIT	MAC: 00:0E:53:EC:A7:B4

Paso 2: En el mismo menú, seleccionar **EaZy**. Habilitar EaZy Networking, y dejar esta página abierta. Necesitará escanear el código QR más tarde.

QUICK START	
GENERAL	ENABLE EAZY NETWORKING ON
TIME SETUP	
DAYLIGHT	
EaZy	 000E532B8613
EXIT	

Paso 3: Abrir EagleEyes en tu móvil y seleccionar ... en la esquina superior izquierda, en el directorio. Después dar click en .

Paso 4: Click **Login** en la sección de **Cloud** y registrar una cuenta en **Cloud Service**. Una vez que haya creado la cuenta, por favor iniciar sesión.

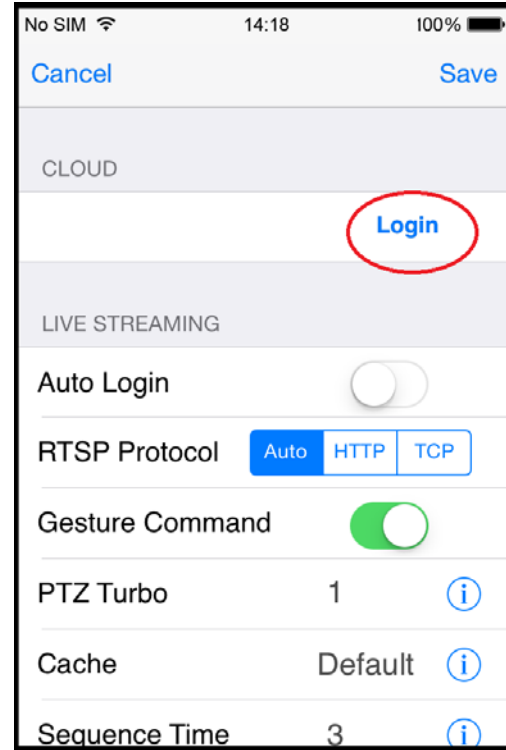
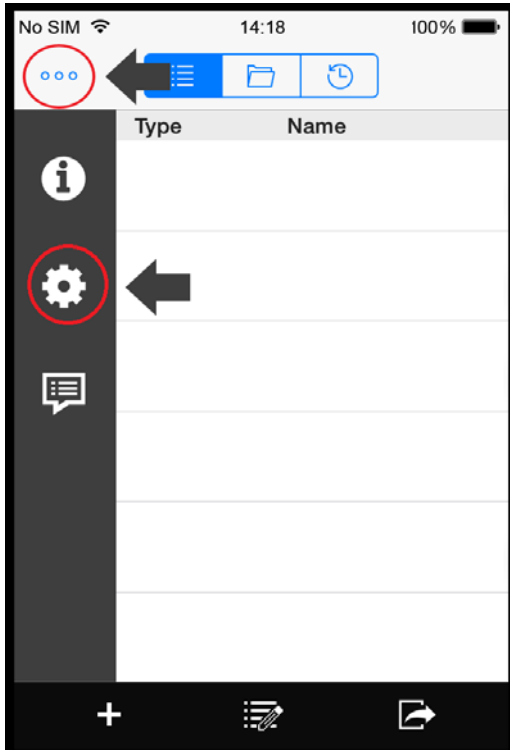

Paso 5: Regresar al directorio y click + para agregar un nuevo equipo.

Hay dos métodos para agregar nuevos equipos; **EaZy** y **Manual**.

Seleccionar **EaZy**, y escoger el ícono de DVR para continuar.

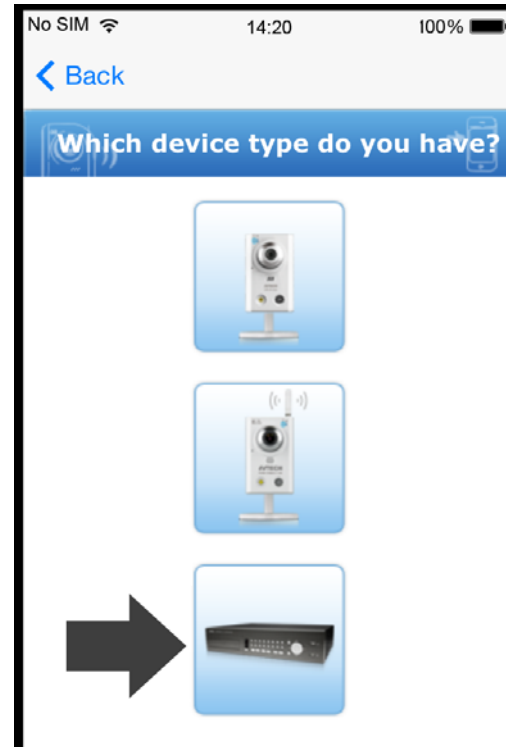

Paso 6: Click  en la sección de **MAC address** para abrir la página del código QR y escanearlo en la página del DVR mencionada en el Paso 2. La dirección MAC se llenará de manera automática. Llenar el código Captcha de forma manual y click **Apply**.

Paso 7: Seguir las instrucciones de una página para terminar el resto de la configuración y ver si este equipo se agregó con éxito al directorio como un equipo de nube.

Al mismo tiempo, se le solicitará confirmar si desea remover el usuario y contraseña de default.

When the default user name and password are removed, you can **ONLY** use the user name and password of the cloud service to access this recorder locally and remotely. If you forget the user name and password of the cloud service, you could only reset the recorder and do all configurations again.

- Cuando sigue usando el usuario y contraseña default, otros usuarios pueden acceder a este grabador si se saben el usuario y contraseña.

Confirmar si desea mantener la cuenta de default para continuar y regresar al directorio. Notará el equipo recién guardado en la dirección con el ícono de la nube.

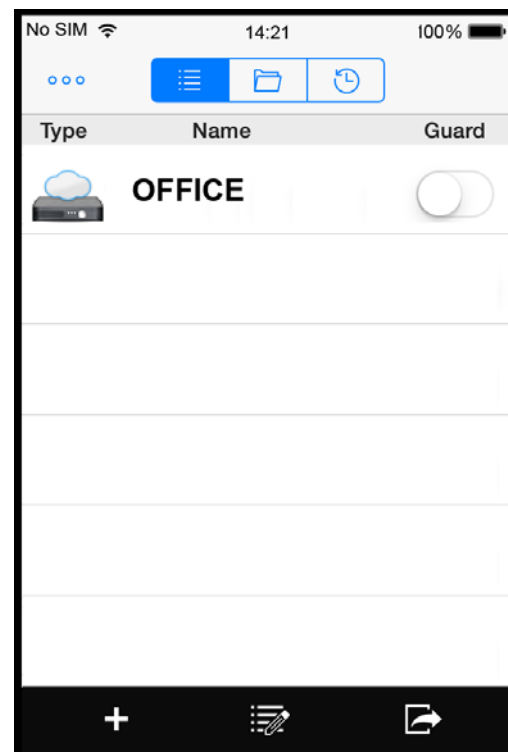

Paso 8: Click en el equipo recién agregado y ver si puede acceder exitosamente.

CONEXION Y CONFIGURACION

Antes de encender el DVR, asegurarse que haya instalado el disco duro, haber conectado al menos una cámara y un monitor HDMI. Para mayores detalles, por favor referirse a la siguiente sección

Nota: El DVR está diseñado para detectar el video system de las cámaras conectadas de manera automática (NTSC or PAL). Para asegurarse que el sistema de detección es correcto, por favor chequear que las cámaras estén conectadas al DVR y a la fuente de poder antes de encender el grabador.

2.1 Instalación de Disco Duro SATA

Al menos un disco duro es necesario para que el DVR pueda grabar video. También, la actualización de firmware puede fallar si no hay disco duro instalado en este grabador.

Cualquiera de los dos siguientes tipos de instalación son aplicables para su DVR. Por favor revisar las instrucciones a continuación par aver qué método de instalación es el adecuado para su grabador.

Tipo 1

Nota: Aquí tomamos como ejemplo un modelo de 8CH de cómo conectar un disco duro a su equipo. Para saber cuántos discos duros pueden instalarse, por favor chequear las especificaciones de su equipo.

Paso 1: Remover la tapa y buscar el conector y bracket del disco duro.

Paso 2: Obtener disco duro compatible. Insertar el disco duro mirando hacia abajo a uno de los conectores.

Nota: Para usar un disco duro verde o ecológico, usar **SOLAMENTE** el tipo de disco duro diseñado especialmente para vigilancia para asegurarse que trabaje corretamente.

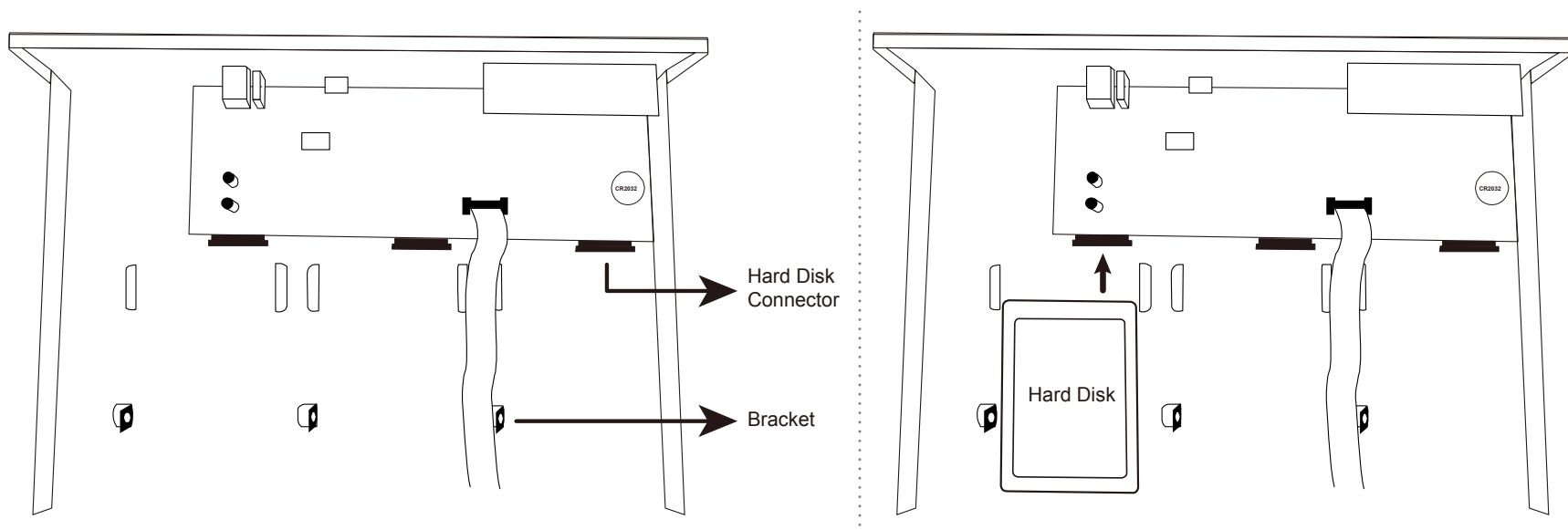

Paso 3: Sujete el disco duro al bracket asegurando el bracket con tornillos.

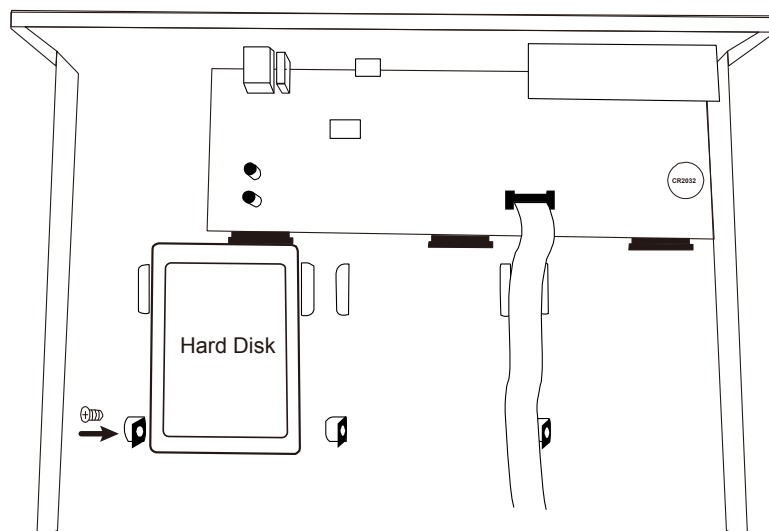

Paso 4: Reemplace la tapa y sujete ls tornillos que aflojó en el Paso 1.

Ttipo 2

Nota: Aquí tomamos como ejemplo un modelo de 8CH de cómo conectar un disco duro a su equipo. Para saber cuántos discos duros pueden instalarse, por favor chequear las especificaciones de su equipo.

Paso 1: Remover la tapa y buscar el conector y bracket del disco duro.

Paso 2: Obtener disco duro compatible. Insertar el disco duro mirando hacia abajo a uno de los conectores.

Nota: Para usar un disco duro verde o ecológico, usar **SOLAMENTE** el tipo de disco duro diseñado especialmente para vigilancia para asegurarse que trabaje corretamente.

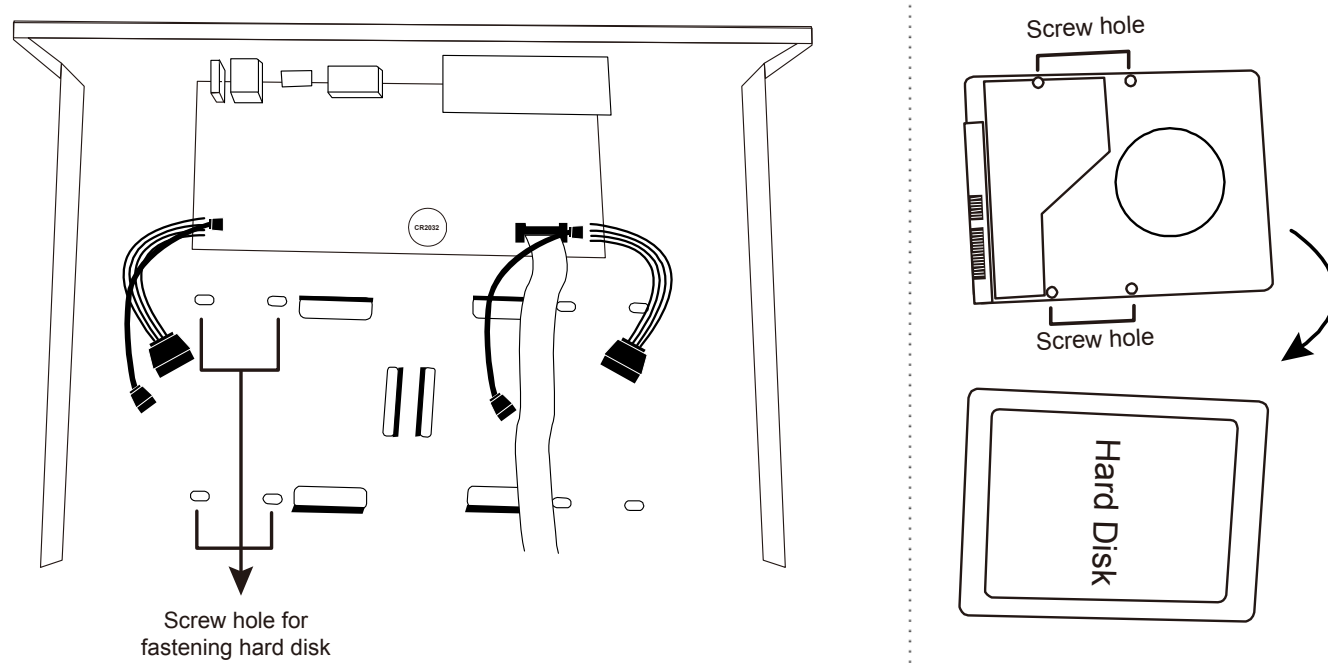

Paso 3: Alinear los agujeros de los tornillos a la base del DVR y el disco duro. Después, sujete el disco duro a la base del DVR con los tornillos proporcionados desde la parte de abajo del grabador.

Paso 4: Conectar el bus de datos y cable de poder para el disco duro.

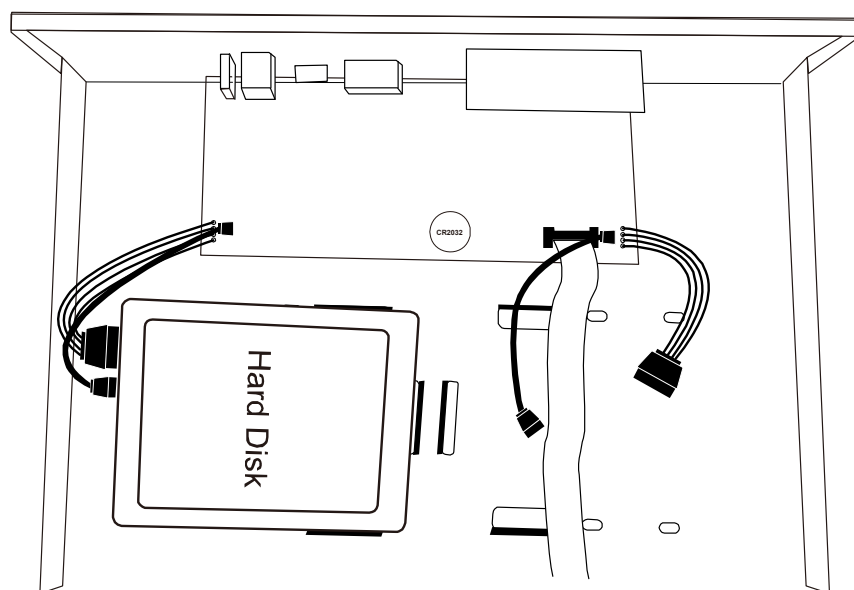

Paso 5: Reemplace la tapa y sujete los tornillos que aflojó en el Paso 1.

2.2 Conexión de cámara

Instale la cámara en la pared o techo dependiendo del ambiente de instalación y el tipo de cámara. Para detalles de instalación, por favor revise el manual de usuario de su cámara.

2.2.1 Cámara Normal

PASO 1: Conecte el cable coaxial al DVR.

PASO 2: (Opcional) Conecte el cable de audio al DVR.

PASO 3: Encienda la cámara y vea si se muestra el video en vivo.

2.2.2 Cámaras de la serie HD CCTV

PASO 1: Conecte el cable coaxial al DVR

PASO 2: Encienda la cámara y vea si se muestra el video en vivo.

PASO 3: Hacer click derecho en el DVR para mostrar el menu principal e ir a  (ADVANCED CONFIG) →











DCCS → **OSD MENU** para configurar la cámara si es necesario.

ADVANCED CONFIG	
CAMERA	CH1 CH2 CH3 CH4
DETECTION	OSD MENU SETUP
ALERT	DCCS MENU SETUP
NETWORK	
DISPLAY	
RECORD	
DEVICES	
DCCS	
IVS	F.W. 1017
NOTIFY	DEVICE AVT Series
JOYSTICK	CONNECTION OK
EXIT	

Serie de Cámaras EZUM

Si las cámaras que conectó son de nuestra serie EZUM, hemos diseñado una serie de íconos para configuración rápida de cámara. Encontrará algunos de los íconos en el siguiente listado para configuraciones rápidas y las sub-funciones de cada ícono podría también variar dependiendo de qué cámara este conectada.

Camino: Parte inferior izquierda en cada canal de vista de la cámara. → 

	Dia & Noche Configura los modos de día y noche de la cámara.		Manejo de IR Ajusta manualmente el brillo de los LEDs del IR.
	Reducción de ruido Reduce ruido de imagen si es necesario.		Óptica Manualmente cambia la velocidad del obturador si es necesario.
	Color Ajustes manuales de parámetros de colores si es necesario.		Mejora de imagen Mejora el desempeño de la imagen para una mejor nitidez e identificación en general aún en áreas con sobre exposición.
	Zoom Se usa con las cámaras de lente motorizado para el zoom óptico.		Hot Point Click en la pantalla para mover el área de vigilancia hacia el punto seleccionado.
	Control de PTZ Abre el panel de control de Pan, Tilt y Zoom y navega la cámara.		Avanzado Configura los parámetros de otra cámara tales como; cámara system, reflejando o volteando imágenes de cámara.

2.2.3 Speed domes o PTZ de otras marcas

Nota: El grabador debe soportar conexión RS485 para poder soportar a la cámara. Revisar las especificaciones de su grabador para mayores detalles.

PASO 1: Conectar el cable coaxial al grabador.

PASO 2: Encontrar los conectores de RS485-A y RS485-B en el panel trasero del DVR y siga las instrucciones del manual de su cámara. Después encienda la cámara.

PASO 3: En el DVR, dar click derecho para mostrar el menu principal e ir a  (ADVANCED CONFIG) → **DEVICES** para configurar la cámara.

- a) Seleccionar el equipo a **PTZ**.
- b) Establecer el ID igual que la cámara.
- c) Seleccionar el protocolo a **P-P**, **P-D**, **S-T** o **S-E**.

Nota: **P-P** y **P-D** son procolos que usa Pelco, **S-T** y **S-E** ason protocolos usados por Samsung.

- d) Establecer la velocidad de transmission al mismo establecido en la cámara.
- e) Estbalecer la interface **RS485**.

ADVANCED CONFIG	
CAMERA	CH1 CH2 CH3 CH4
DETECTION	DEVICE PTZ ▼
ALERT	ID 000
NETWORK	PROTOCOL P-P ▼
DISPLAY	RATE 2400 ▼
RECORD	INTERFACE RS485 ▼
DEVICES	
DCCS	
IVS	
NOTIFY	
JOYSTICK	
EXIT	

2.2.4 Cámara IP

Nota: Revisar las especificaciones de su DVR y ver si el DVR soporta conexión de cámaras IP.

PASO 1: Conectar la cámara al mismo switch/ router al que el DVR está conectado y encender la cámara.

PASO 2: En el DVR, si mueve el cursor hacia la izauiera, se mostrará la barra rápida y usted seleccione  (IP Search) para encontrar su cámara.

IP SEARCH					
IP	PORT	MAC	TYPE	PROTOCOL	STATUS
10.1.1.12	88	00:0e:53:e5:9a:f1	IP CAMERA	AVTECH	UNUSED
10.1.1.12	88	UNKNOWN	IP CAMERA	ONVIF	UNUSED
			CONNECT	SETUP	EXIT

PASO 3: Seleccione la dirección IP que no está en uso y seleccione **CONNECT** para asignar el canal en el que se mostrará el video en vivo.

2.3 DVR Power On

Este equipo debe ser operado únicamente con la fuente de poder indicada en la etiqueta del fabricante. Conectar el cable al adaptador AC y después conectar a un toma corriente.

Si su equipo tiene un switch en el panel del lado, moverlo a “—”. La luz LED se encenderá. Si su equipo no tiene un switch de encendido en el panel del lado, el equipo se encenderá una vez que lo conecte a una fuente de energía.

Nota: Antes de engender el DVR, asegurarse de (1) que las cámaras estén conectadas al grabador y a una fuente de poder para que la detección de video system sea correcta, y (2) que un monitor este conectado al DVR para la detección correcta de video.

Nota: Para asegurarse que su DVR trabaja de forma constant y apropiada, se recomienda usar un UPS o Uninterruptible Power Supply (Opcional), para operación continua.

Nota: Cuando su DVR este encendido, revisar el capítulo “3. FOR INITIAL USE” en el manual de usuario para saber cómo configurar este equipo y cambiar el usuario y contraseña de default. Para descargar el manual de usuario, escanear el siguiente código QR en la primera página o vaya a www.surveillance-download.com/user/z404.swf.