

H.265 XVR SERIES

USER MANUAL

Please read instructions thoroughly before operation and retain it for future reference. For the actual display & operation, please refer to your device in hand.



Free PC CMS
software (CMS Lite)

IMPORTANT SAFEGUARD



All lead-free products offered by the company comply with the requirements of the European law on the Restriction of Hazardous Substances (RoHS) directive, which means our manufacture processes and products are strictly "lead-free" and without the hazardous substances cited in the directive.



The crossed-out wheeled bin mark symbolizes that within the European Union the product must be collected separately at the product end-of-life. This applies to your product and any peripherals marked with this symbol. Do not dispose of these products as unsorted municipal waste. Contact your local dealer for procedures for recycling this equipment.



This is a class A product. In a domestic environment this product may cause radio interference in which case the user may be required to take adequate measures.

Federal Communications Commission Interference Statement

This equipment has been tested and found to comply with the limits for a Class A digital device, pursuant to Part 15 of the FCC Rules. These limits are designed to provide reasonable protection against harmful interference when the equipment is operated in a commercial environment. This equipment generates, uses, and can radiate radio frequency energy and, if not installed and used in accordance with the instruction manual, may cause harmful interference to radio communications. Operation of this equipment in a residential area is likely to cause harmful interference in which case the user will be required to correct the interference at his own expense.

This device complies with Part 15 of the FCC Rules. Operation is subject to the following two conditions:

- (1) This device must not cause harmful interference, and
- (2) This device must accept any interference received, including interference that may cause undesired operation.

Disclaimer

iPad and iPhone are trademarks of Apple Inc., registered in the U.S. and other countries. App Store is a service mark of Apple Inc.

IOS is a trademark or registered trademark of Cisco in the U.S. and other countries and is used under license.

Google Play and Android are trademarks of Google Inc

We reserve the right to revise or remove any content in this manual at any time. We do not warrant or assume any legal liability or responsibility for the accuracy, completeness, or usefulness of this manual. The content of this manual is subject to change without notice.

This product doesn't have a standby / off mode.

MPEG4 Licensing

THIS PRODUCT IS LICENSED UNDER THE MPEG4 VISUAL PATENT PORTFOLIO LICENSE FOR THE PERSONAL AND NON-COMMERCIAL USE OF A CONSUMER FOR (i) ENCODING VIDEO IN COMPLIANCE WITH THE MPEG4 VISUAL STANDARD ("MPEG-4 VIDEO") AND/OR (ii) DECODING MPEG4 VIDEO THAT WAS ENCODED BY A CONSUMER ENGAGED IN A PERSONAL AND NON-COMMERCIAL ACTIVITY AND/OR WAS OBTAINED FROM A VIDEO PROVIDER LICENSED BY MPEG LA TO PROVIDE MPEG4 VIDEO. NO LICENSE IS GRANTED OR SHALL BE IMPLIED FOR ANY OTHER USE. ADDITIONAL INFORMATION INCLUDING THAT RELATING TO PROMOTIONAL INTERNAL AND COMMERCIAL USES AND LICENSING MAY BE OBTAINED FROM MPEG LA, LLC. SEE [HTTP://WWW.MPEGLA.COM](http://www.mpegla.com).

GPL Licensing



This product contains codes which are developed by Third-Party-Companies and which are subject to the GNU General Public License ("GPL") or the GNU Lesser Public License ("LGPL").

The GPL Code used in this product is released without warranty and is subject to the copyright of the corresponding author.

Further source codes which are subject to the GPL-licenses are available upon request.

We are pleased to provide our modifications to the Linux Kernel, as well as a few new commands, and some tools to get you into the code. Please write to marketing@avtech.com.tw to get the files.

TABLE OF CONTENTS

1. HARDWARE OVERVIEW	1
1.1 Package Content.....	1
1.2 Front Panel.....	1
1.3 Rear Panel	1
2. CONNECTION.....	3
2.1 Hard Disk Installation	3
2.2 Hard Disk Mounting.....	5
2.3 Camera Connection	5
2.3.1 HD CCTV camera & our brand's speed dome camera.....	5
2.3.2 Other brand's speed dome camera.....	5
2.3.3 IP Camera	6
3. FOR INITIAL USE	7
3.1 Setup Wizard.....	7
3.2 Mount / Unmount Hard Disk	9
3.3 Change User Name and Password.....	9
4. USER INTERFACE	11
4.1 Local Access	11
4.2 Interface Overview	11
4.3 Status & Operation	12
4.3.1 Device Status	12
4.3.2 Channel Status.....	12
4.3.3 Main Menu.....	13
4.3.4 Playback Panel.....	15
5. FREQUENTLY-USED FUNCTIONS	16
5.1 IP Device Search.....	16
5.2 User Account Creation	17
5.3 PTZ Control	18
5.4 Video Backup	19
5.5 System Logout	20
5.6 Hardware Reset	20
6. MAIN MENU	21
6.1 CAMERA.....	21
6.1.1 CONNECTION	21
6.1.2 DEVICE	21
6.1.3 IMAGE.....	23
6.1.4 DETECTION.....	23
6.1.5 ALARM OUT.....	26
6.2 RECORD.....	26
6.3 SCENARIO.....	28
6.3.1 Pre-defined Scenarios.....	28
6.3.2 Scenario Customization	35
6.4 IVS (<i>For selected models only</i>)	39
6.5 EXPORT.....	42
6.5.1 BACKUP.....	42
6.5.2 SCHEDULE.....	43
6.5.3 REGULAR REPORT	44

6.6 STORAGE	45
6.7 ACCOUNT	46
6.7.1 USER LIST	46
6.7.2 GROUP	47
6.8 NETWORK	48
6.8.1 E-MAIL	48
6.8.2 FTP	49
6.8.3 EaZy	49
6.9 TIME	49
6.9.1 TIME SETUP	49
6.9.2 DAYLIGHT	50
6.10 DISPLAY	50
6.11 PERIPHERAL	52
6.11.1 LOCAL	52
6.11.2 JOYSTICK	52
6.11.3 LOCAL ALARM IN	53
6.11.4 LOCAL ALARM OUT	53
6.11.5 DEVICES	54
6.12 MAINTAIN	54
6.12.1 SYSTEM	54
6.12.2 UPGRADE	55
6.12.3 ALERT	56
6.12.4 EVENT LOG	57
6.12.5 ONLINE	57
6.13 POWER CONTROL	57
6. REMOTE OPERATION	58
6.2 Web Browser	58
6.3 Mobile Devices	59
6.3.1 Prerequisites	59
6.3.2 Where to download	59
6.3.3 Manual Setup	59
APPENDIX 1 PRODUCT SPECIFICATIONS	61
APPENDIX 2 PUSH VIDEO CONFIGURATION	67
A2.1 Alarm Sensor Connection	69
A2.2 Configuration	70
A2.3 Enable Push Video	70
A2.3.1 From iOS Mobile Device	70
A2.3.2 From Android Mobile Device	71
APPENDIX 3 COMPATIBLE USB FLASH DRIVE LIST	72
APPENDIX 4 COMPATIBLE HARD DISK LIST	73
APPENDIX 5 BATTERY REPLACEMENT	74
APPENDIX 6 EAZY NETWORKING	75
A8.1 Via EagleEyes on iOS / Android Device	75
A8.2 Via Internet Explorer on PC / Laptop	80
A8.3 Icons	85

1. HARDWARE OVERVIEW

1.1 Package Content

➤ Standard Package

- | | |
|---|--------------------------------------|
| <input type="checkbox"/> Recorder | <input type="checkbox"/> HDD screws |
| <input type="checkbox"/> Adapter & power cord | <input type="checkbox"/> Quick Start |



➤ Optional Accessories

- | | |
|------------------------------------|---|
| <input type="checkbox"/> USB Mouse | <input type="checkbox"/> IR Remote Controller |
|------------------------------------|---|

1.2 Front Panel

Note: The functions on the front panel may vary, depending on the mode you have.

1) LED Indicators

-  The hard disk is reading or recording.
 An alarm is triggered.

2) USB port(s)

There might be one or two USB ports on the front panel for connecting your USB mouse for mouse control and / or your USB flash drive for video backup.

Note: It's not allowed to have two USB mice or two USB flash drives connected to one recorder.

Note: For 8CH and 4CH models which have one USB port on the front panel and two USB ports on the rear panel, the upper USB port on the rear panel will be disabled when the USB port on the front panel is used, and vice versa.

Note: For the compatible list of USB flash drives, please refer to "APPENDIX 3 COMPATIBLE USB FLASH DRIVE LIST" at page 72.

1.3 Rear Panel

Note: The functions on the rear panel may vary, depending on the mode you have.

1) VIDEO IN

Connect to the video connector of a camera.

Note: The DVR will automatically detect the video system of the camera, please make sure that the cameras are properly connected to the recorder and power-supplied before the recorder is turned on.

2) VIDEO OUT

Connect to a CRT monitor for main or spot monitor output.

3) AUDIO IN

Connect to the audio connector of a camera if the camera supports audio recording.

Note: To make a video backup with audio, make sure the camera which supports the audio function is connected to the video-in channel and audio-in channel. For example, the audio data from audio CH1 will be recorded with the video data from video CH1.

For 16CH models, the audio CH1 ~ CH2 are corresponding to video CH1 ~ CH2 respectively.

4) AUDIO OUT

Connect to a speaker for audio transmission.

5) HDMI

Connect to the HDMI port of the monitor which supports HDMI video output for main or spot monitor output.

6) VGA

Connect to the VGA port of the monitor which supports VGA video output for main display or spot monitor output.

7) External I/O ports

These ports are used to connect external I/O devices, such as magnetic contacts or buzzers (alarm in / out), or external control devices, such as other brand's speed dome camera or keyboard controller (RS485).

8) LAN

This port is used to connect your device to Internet.

9) USB ports

There might be two USB ports on the rear panel for connecting your USB mouse for mouse control and your USB flash drive for video backup.

Note: It's not allowed to have two USB mice or two USB flash drives connected to one recorder.

Note: For 8CH and 4CH models which have one USB port on the front panel and two USB ports on the rear panel, the upper USB port on the rear panel will be disabled when the USB port on the front panel is used, and vice versa.

Note: For the compatible list of USB flash drives, please refer to "APPENDIX 3 COMPATIBLE USB FLASH DRIVE LIST" at page 72.

10) Power jack

Connect to the supplied adapter.

11) Reserved hole for eSATA interface

For models which support adding an eSATA interface with the optional SATA-to-eSATA cable, there's a reserved hole on the rear panel.

Please check "2.1 Hard Disk Installation" at page 3 to know where it is and how to add the interface for storage expansion.

2. CONNECTION

2.1 Hard Disk Installation

Note: The illustrations below are using a 4CH model as an example. The methods of how to install a hard disk are the same for all models.

Note: It's necessary to install a hard disk first before firmware upgrade to ensure the upgrade process works properly.

Step1: Remove the top cover, and find where to install a hard disk on the recorder.

Step2: Get a compatible hard disk. With the PCB side facing down, find the screw holes on the recorder base, and place the hard disk in the recorder.

Note: To use a green hard disk, use **ONLY** the hard disk designed especially for surveillance to ensure the device works properly.

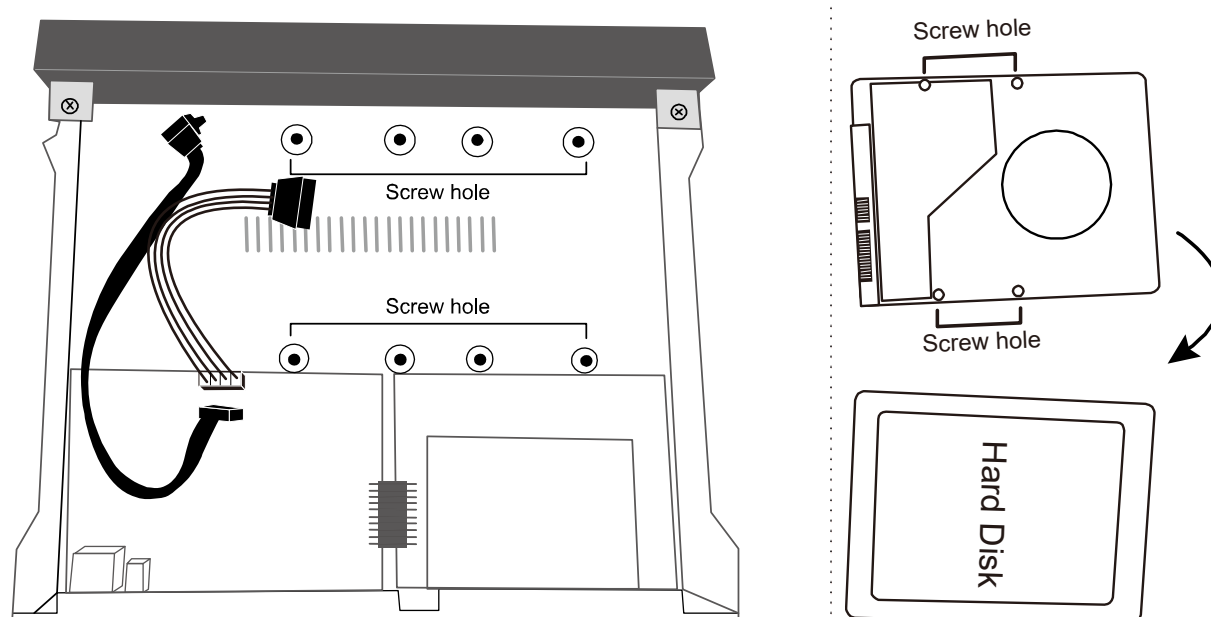

Step3: Connect the data bus and power cable for the hard disk.

Step4: Align the screw holes on the base and the hard disk. Then, fasten the hard disk on the base with the supplied screws from the bottom side of the recorder.

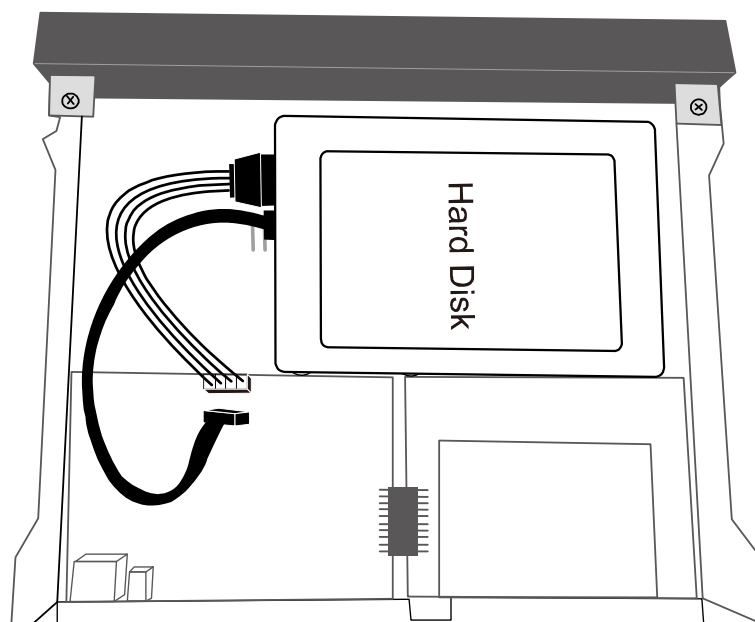

Step5: Replace the top cover and fasten the screws you loosened in Step1.

Step6: Remove the protective film on the bottom of the recorder if any to ensure the heat dissipation can work normally.

Install a third hard disk (optional)

- Step1: Check the specifications of your recorder and see if it supports this feature. If yes, find the hard disk bracket as illustrated on the right and remove it.
- Step2: Get a compatible hard disk. With the PCB side facing up, fasten the hard disk to the bracket as illustrated on the right.
- Step3: Reinstall the bracket with the hard disk installed back to your recorder.
- Step4: Connect the data bus and power cable for the hard disk.

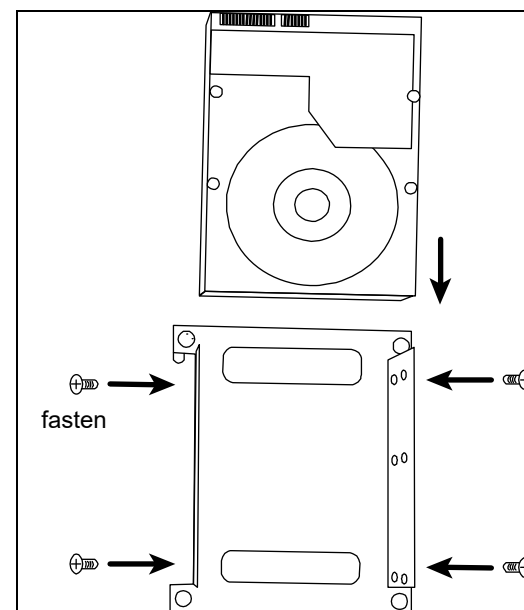

Add eSATA interface with optional SATA-to-eSATA cable

Note: The illustrations below are using a 16CH model as an example. The methods of how to install the cable are the same for all models which support this feature.

- Step1: Check the specifications of your recorder and see if it supports this feature. If yes, find the reserved hole on the rear panel of your recorder as illustrated on the right.
- Step2: Remove the top cover of the recorder to reveal its main board. Remove the thin piece of metal that block the reserved hole. Then, remove the SATA cable on the board.

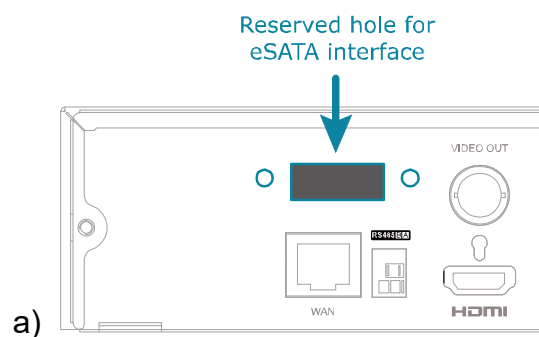

Note: It will consume one SATA port to add an eSATA interface on the mainboard of your recorder, which means you'll lose one hard disk which can be **installed** inside your recorder.

Step3: Get a SATA-to-eSATA cable and connect it to the board as illustrated below.

Note: The SATA-to-eSATA cable is optional and need to purchase separately.

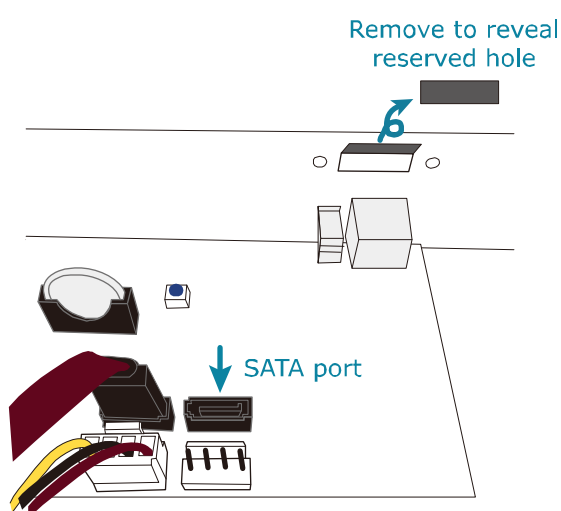

Figure 1

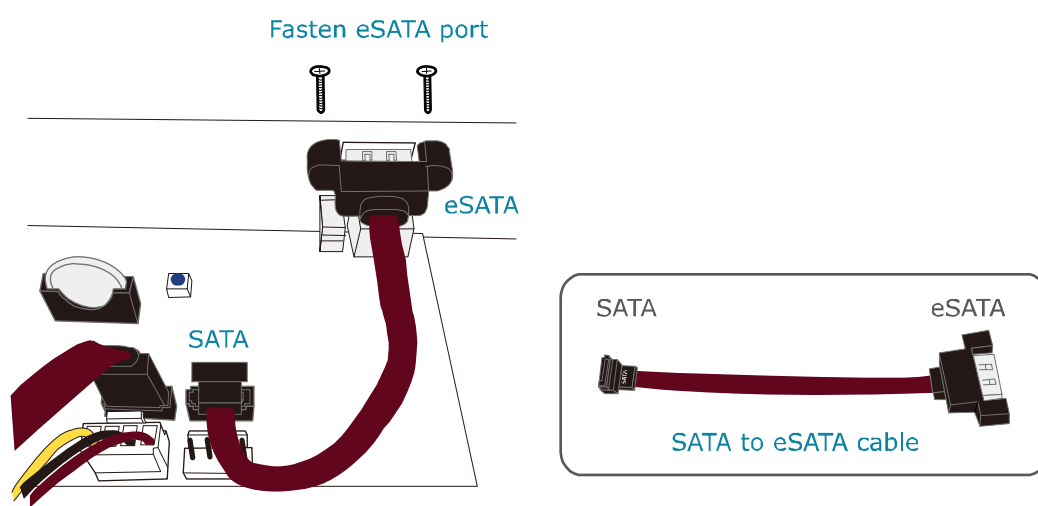



Figure 2

2.2 Hard Disk Mounting

Power on your recorder and wait till the initialization is completed. Then, check the hard disk indicators on the front panel to make sure each hard disk installed is detected.

Right click the mouse to exit from the full screen mode. Click **MENU** → **STORAGE** to see if all hard disks you inserted are detected, and click  one by one to mount them. Wait till the hard disk is mounted and the status shows **READY**. When you're prompted to clear the hard disk, choose **YES**.

2.3 Camera Connection

Install the camera on the wall or ceiling based on your installation environment and camera type. For installation details, please refer to the user manual of your camera.

2.3.1 HD CCTV camera & our brand's speed dome camera

Step1: Connect the coaxial cable to the recorder.

Step2: Get a regulated adapter to connect the camera and power it on.

2.3.2 Other brand's speed dome camera

Note: The recorder must support RS485 connection to connect a speed dome camera. Please check the specifications of your recorder for details.

Step1: Connect the coaxial cable to the recorder.

Step2: Find where the connectors of RS485-A and RS485-B are located on the recorder rear panel, and follow the instructions of your camera manual to connect to the recorder. Then, power on the camera.

Step3: On the recorder side, right click to show the main menu, and go to **MENU** → **PERIPHERAL** → **DEVICES** to set the camera.

a) Select the device to **PTZ**.

b) Set the ID to the value the same as the one set in the camera.

c) Select the protocol to **P-P**, **P-D**, **S-T** or **S-E**.

Note: **P-P** and **P-D** are protocols used Pelco, and **S-T** and **S-E** are protocols used by Samsung.

d) Set the baud rate to the value the same as the one set in the camera.

e) Set the interface to **RS485**.

LOCAL JOYSTICK	DEVICES									
	CHANNEL TITLE	DEVICE		ID	PROTOCOL		RATE		INTERFACE	
DEVICES	CH1	PTZ	∨	1	P-P	∨	9600	∨	RS485	∨
	CH2	PTZ	∨	0	NORMAL	∨	2400	∨	COAXIAL	∨
	CH3	PTZ	∨	0	NORMAL	∨	2400	∨	COAXIAL	∨
	CH4	PTZ	∨	0	NORMAL	∨	2400	∨	COAXIAL	∨

2.3.3 IP Camera

Note: Check the specifications of your recorder and see if your recorder supports IP camera connection.

Step1: Prepare a switch / router, and connect the recorder and the IP camera to the router with RJ45 network cables.

Step2: Make sure your camera supports DHCP function to allow the connected router to assign an IP address to the camera.

If your camera doesn't support this function, please check its user manual to know how to manually change the IP address of your camera and make sure its IP address is in the same network segment as the one your router uses.

Step3: Power on the camera.

Step4: On the recorder's live view, choose **MENU → CAMERA → CONNECTION** to go to the setting page. For the channel to which you want to connect the IP camera, change the interface from **COAXIAL** to **IPCAM**.

CONNECTION												
CHANNEL TITLE	INTERFACE	EDIT	<input type="checkbox"/> ENABLE	URI	PORT	DEVICE TYPE	VENDOR	MODEL	STREAM PROTOCOL	METHOD	PATH1	PATH2
CH1	IPCAM			<input type="checkbox"/>	192.168.1.11	88	IPCAM	AVTECH	RTP-Unicast	TCP		
CH2	IPCAM			<input type="checkbox"/>								
CH3	COAXIAL			<input type="checkbox"/>								
CH4	COAXIAL			<input type="checkbox"/>								

Step5: Choose **IP SEARCH** to go to the **IP SEARCH** page directly and start searching the connected IP cameras.

You'll see the list of every connected IP camera with its connection status to this device and MAC address. Click to assign the camera to the channel automatically and choose **ADD** to complete.

IP SEARCH										
ASSIGN	EDIT	DEVICE TYPE	IP	NETMASK	GATEWAY	PRIMARY DNS	PORT	MAC	VENDOR	
<input checked="" type="checkbox"/>		IPCAM	192.168.1.12	255.255.255.0	192.168.1.1	8.8.8.8	88	00:0E:53:31:06:E5	AVTECH	
<input type="checkbox"/>		IPCAM	192.168.1.12	255.255.255.0	0.0.0.0	8.8.8.8	88	00:0E:53:31:06:E5	ONVIF	
<input type="checkbox"/>		IPCAM	192.168.1.13	255.255.255.0	192.168.1.1	8.8.8.8	88	00:0E:53:31:15:D1	AVTECH	
<input type="checkbox"/>		IPCAM	192.168.1.13	255.255.255.0	0.0.0.0	8.8.8.8	88	00:0E:53:31:15:D1	ONVIF	

3. FOR INITIAL USE

For the first time to power on this device, you might be prompted to:

- Go through the setup wizard
- Clear hard disk
- Change default user name and password

3.1 Setup Wizard

The setup wizard is prompted to guide you finishing the most common settings you might need to do.

Note: It's okay to skip the wizard. You can configure the following settings later in their respective menus.

SETUP WIZARD	
	ENGLISH ▼
<p>WELCOME TO THE SETUP WIZARD. PLEASE FOLLOW THE WIZARD TO FINISH BASIC CONFIGURATIONS.</p>	
SKIP	NEXT

Select **NEXT** to go to the next step.

SETUP WIZARD	
<p>PLEASE INPUT THIS MACHINE NAME</p> <input style="width: 100px; height: 20px;" type="text"/>	
SKIP	PREV NEXT

Name the device. If you don't want to name the device, just skip to the next step.

Note: To name the device later, please go to **MAINTAIN** → **SYSTEM**.

SETUP WIZARD	
USER NAME	office_hd
PASSWORD	office145
CONFIRM PASSWORD	office145
<p>PLEASE INPUT THE ADMINISTRATOR'S USER NAME AND PASSWORD.</p>	
SKIP	PREV NEXT

Change the default user name and password. If you don't change the user name and password here, you're not able to go to the next step. This step is compulsory.

Note: To change or edit user name and passwords, please go to **SYSTEM** → **ACCOUNT** → **USER LIST**.

SETUP WIZARD	
DATE	2015/MAR/05
TIME	14:33:46
FORMAT	Y/M/D ▼
GMT	GMT+08:00 ▼
<div style="display: flex; justify-content: space-between; align-items: center;"> SKIP PREV NEXT </div>	

Set the date and time.

If you don't want to set the date and time now, just skip to the next step. However, it's necessary to keep the date and time right to ensure the accuracy of the recorded data.

Note: To set the date and time later, please go to **MENU** → **TIME**.

SETUP WIZARD	
NTP SERVER	Pool.ntp.org
SYNC PERIOD	OFF ▼
<div style="display: flex; justify-content: space-between; align-items: center;"> SKIP PREV NEXT </div>	

Configure if you want to connect this device to an NTP server to get the right time online.

Note: To set the date and time later, please go to **MENU** → **TIME**.

SETUP WIZARD	
NETWORK TYPE	STATIC ▼
IP	192.168.1.10
GATEWAY	192.168.1.1
NETMASK	255.255.255.0
PRIMARY DNS	8.8.8.8
SECONDARY DNS	168.95.1.1
PORT	80
<div style="display: flex; justify-content: space-between; align-items: center;"> SKIP PREV NEXT </div>	

Configure network setup by using the traditional method. For details, please download www.surveillance-download.com/user/network_setup/network_setup_recorder.pdf.

Note: To configure network setup by using the traditional method later, please go to **MENU** → **NETWORK**.

SETUP WIZARD	
SMTP SERVER	Smtplib@gmail.com
PORT	465
MAIL FROM	manager@gmail.com
SSL ENCRYPTION	ON
VERIFY PASSWORD	ON
USER NAME	manager@gmail.com
PASSWORD	●●●●●●
<div style="display: flex; justify-content: space-between; align-items: center;"> SKIP PREV NEXT </div>	

Configure event notifications by email.

Note: To configure email notifications later, please go to **MENU** → **NETWORK** -> **E-MAIL**.

SETUP WIZARD	
DDNS	ON
SYSTEM NAME	Eagleeyes ▼
HOST NAME	MAC000E533A3D
E-MAIL	
CURRENT HOST ADDRESS	MAC000E533A3D4A.ddns.eagleeyes.tw
SKIP	PREV NEXT

Enable DDNS if needed.







Note: To enable the DDNS later, please go to **MENU** → **NETWORK** → **DDNS**.

3.2 Mount / Unmount Hard Disk

Power on your recorder and wait till the initialization is completed. Then, check the hard disk indicators on the front panel to make sure each hard disk installed is detected.

Right click the mouse to exit from the full screen mode. Click **MENU** → **STORAGE** to see if all hard disks you inserted are detected, and click  one by one to mount them. Wait till the hard disk is mounted and the status shows **READY**. When you're prompted to clear the hard disk, choose **YES**.

To unmount the hard disk, click  to unmount, and the status will turn from **READY** to **INACTIVE**.

STORAGE									
HDD NEARLY FULL (GB)							5	▼	
HDD OVERHEAT ALERT (°C)							70	▼	
OVERWRITE							ON		
KEEP DATA LIMIT(DAYS)							OFF	▼	
TEMPERATURE TO ENABLE FAN							30	▼	
REMINDER WHEN FORMATTING HDD							OFF		
	ID	TYPE	STATUS	SIZE	TEMP.	SERIAL NUMBER	FREE SIZE	FORMAT TIME	HEALTH STATUS
  	HDD 5-1	NORMAL	INACTIVE	750GB	--	WD-WCAV53797317	269.856GB	2017/07/18 23:03:52	GOOD
  	HDD 5-2	NORMAL	READY	1.00TB	--	WD-WMC1U5344933	9.88GB	2017/07/18 23:10:55	GOOD

3.3 Change User Name and Password



It's highly recommended to change the user name and password of this device to keep your account safe. Otherwise, any person could access this device if he knows the default user name and password.

If you didn't go through the setting wizard at the first place, you'll be prompted to change the user name and password:

WARNING
PLEASE BE ADVISED TO MODIFY THE DEFAULT ACCOUNT TO ENSURE YOUR INFORMATION SECURITY.
<input checked="" type="radio"/> MODIFY <input type="radio"/> REMIND ME LATER <input type="radio"/> DON'T REMIND ME ANYMORE
CONFIRM

Choose **MODIFY** to start the change immediately.

To change later, go to **MENU** → **ACCOUNT** → **USER LIST**, and choose  to change the default user name and password of **SUPERVISOR**.

USER LIST		USER LIST		
GROUP	EDIT	USER NAME	GROUP	
	 	admin	SUPERVISOR	
				

4. USER INTERFACE

4.1 Local Access

Connect an USB mouse to the recorder and move your mouse to enter the password with the password keypad. The default user name and password are both **admin**.

When you log into the system, the display is in the full screen mode. Right click the mouse to show the tool bar and function panel.

Note: You may also customize a user level to have different access privileges in **ACCOUNT** → **GROUP**. For details, please refer to "6.7.2 GROUP" at page 47.

Password Input

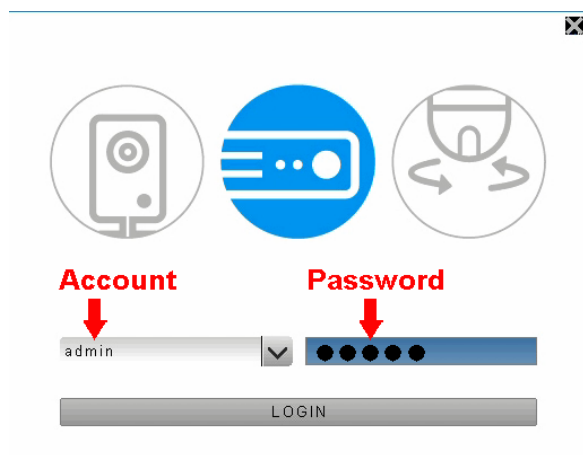















4.2 Interface Overview







4.3 Status & Operation

4.3.1 Device Status

Note: The functions shown may vary based on the model or the access user level you use.















	Key lock		Key unlock
	USB flash drive / device connected		No USB device connected
	Timer record on		Timer record off
	Overwrite on		Overwrite off
	Sequence mode on		Sequence mode off
	PTZ mode on		PTZ mode off
	USB backup in progress		USB flash drive full
	USB backup failed		

Network Status:

	(WAN) Internet connected		(WAN) Internet disconnected
	(WAN) Local connection		
	(LAN) DHCP / Static IP mode		(LAN) Camera disconnected







4.3.2 Channel Status

Note: The functions shown may vary based on the model or the access user level you use.

■ IP-camera-related icons (for selected models only)							
	Camera disconnected		Add a camera by auto search		Add a camera manually		IP camera setup
■ General icons							
	Audio on		Audio off		Alarm out		Alarm out disabled
	Recording		Alarm event		Motion event		PIR event
	Original size		Fit to screen		Digital zoom		

4.3.3 Main Menu

Click **MENU** on the bottom left corner to show the main menu list and its sub items:

	CAMERA	CONNECTION	IP SEARCH*
		DEVICE	
		IMAGE	BRIGHTNESS
			CONTRAST
			SATURATION
			HUE
		DETECTION	
ALARM OUT*			
	RECORD	LIVE STREAM	
		RECORD STREAM	
		SUBSTREAM	
	SCENARIO*		
	IVS*	IVS MODE	FLOW COUNTING
			ONEWAY
			VIRTUAL FENCE
		DISPLAY LINE	
		DISPLAY COUNT	
		SCENE CHANGE	
		SCENE CHANGE LEVEL	
SENSITIVITY			
	EXPORT	BACKUP	
		SCHEDULE	
		REGULAR REPORT	
	STORAGE		HDD NEARLY FULL (GB)
			HDD OVERHEAT ALERT (°C)
			OVER WRITE
			KEEP DATA LIMIT(DAYS)
			TEMPERATURE TO ENABLE FAN (°C)
			REMINDER WHEN FORMATTING HDD
	ACCOUNT	USER LIST	
		GROUP	
	NETWORK	WAN	
		DDNS	
		E-MAIL	
		FTP	
		EAZY	
	TIME	TIME SETUP	DATE
			TIME
			FORMAT
			NTP SERVER
			SYNC PERIOD
			GMT
			CLIENT TIME SYNC VIA RECORDER
		SYNC NTP SERVER TIME	
DAYLIGHT			

*For selected models only

	DISPLAY		CHANNEL TITLE
			EVENT STATUS
			AUTO KEY LOCK(S)
			HDD DISPLAY MODE
			DISPLAY OUTPUT
			LANGUAGE
			SPOT MONITOR*
			CALL SCREEN DURATION
			QUAD SCREEN DURATION
	PERIPHERAL	LOCAL	MOUSE SENSITIVITY
			REMOTE CONTROL ID
		JOYSTICK	
		LOCAL ALARM IN*	
		LOCAL ALARM OUT*	
		DEVICES	
	MAINTAIN	SYSTEM	BACKUP CONFIG
			RESTORE CONFIG
			RESET DEFAULT
			DEVICE TITLE
			ENABLE AUTO PLUG AND PLAY
			BIND MAC ADDRESS
		UPGRADE	LOCAL
			CAMERA
		ALERT	EXT. ALERT
			INT. ALERT
			KEY BUZZER
			VLOSS BUZZER
			MOTION BUZZER
			ALARM BUZZER
			HDD BUZZER
			ALARM BUZZER DURATION (SEC)
		EVENT LOG	
		ONLINE	ANONYMOUS VIEWER LOGIN
			DROP ALL CONNECTION
			LOGIN FAILURE TIMES
LOCK TIME FOR LOGIN FAILURES			
	POWER CONTROL	HALT THE SYSTEM	
		REBOOT THE SYSTEM	
		LOGOUT	

*For selected models only





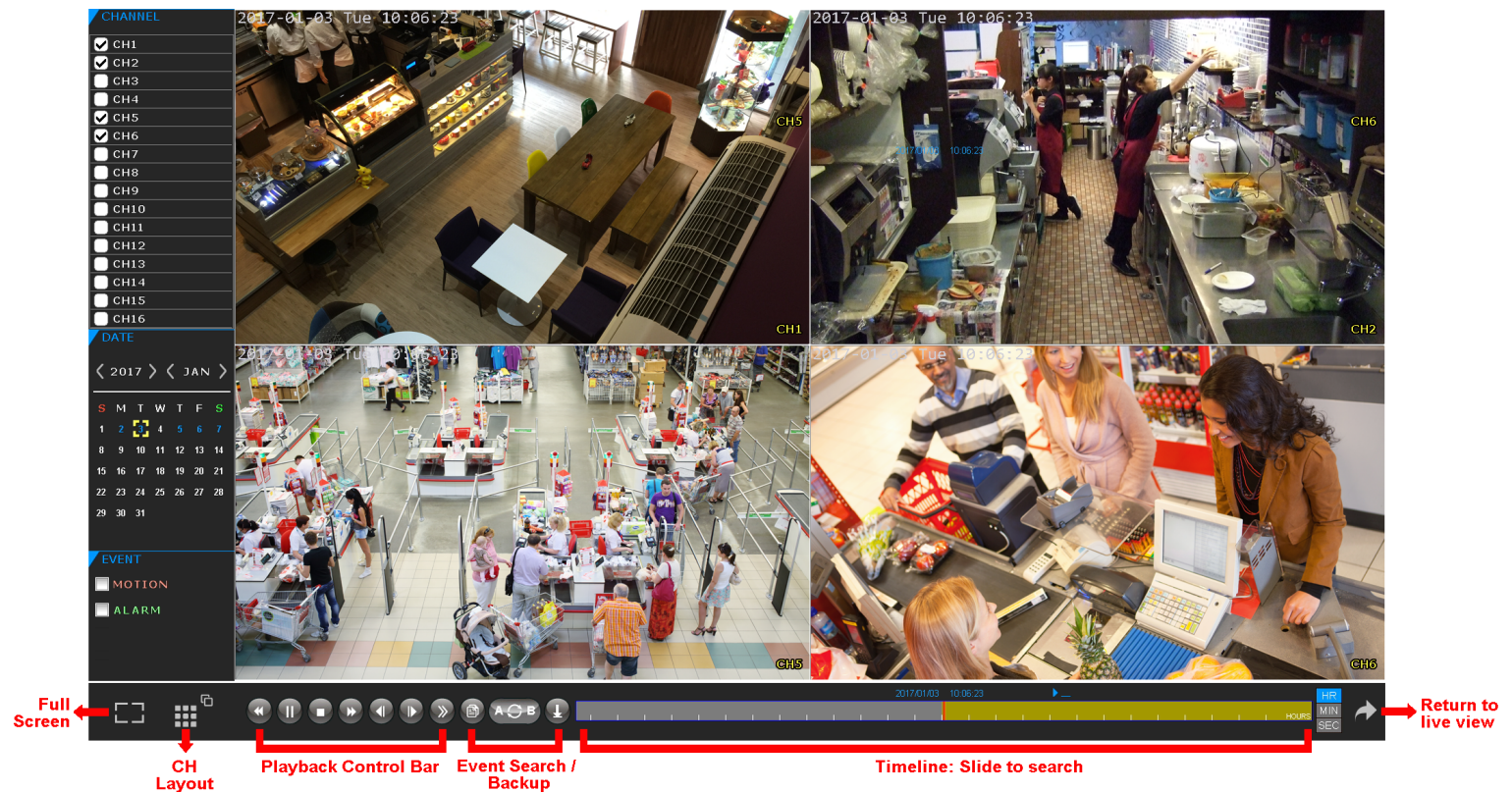





4.3.4 Playback Panel

Click  to go to the playback panel.



- Step1: In **CHANNEL**, choose the channel(s) you want to search.
- Step2: In **DATE**, the date(s) which includes video footage of the selected channel(s) will be marked in blue. Choose the date you want.
- Step3: (Optional) In **EVENT**, choose the event type(s) to narrow down the search if needed.
- Step4: Slide the timeline to search the time segment within which includes video footage. The time segment within which includes video footage is marked in yellow-green.
- Step5: Move to the time segment you want and video playback starts automatically.

Playback Control

	Fast Forward	Increase the speed for fast forward.
	Fast Rewind	Increase the speed for fast rewind.
	Play / Pause	Click to play the latest recorded video clip immediately, and click again to pause. In the pause mode, click  once to get one frame forward, and click  to get one frame rewind.
	Stop	Click to stop the video playback.
	Slow Playback	Click once to get 1/4X speed playback, and click twice to get 1/8X speed playback.
	Previous / Next Hour	Click to jump to the next / previous time interval in an hour, for example, 11:00 ~ 12:00 or 14:00 ~ 15:00, and start playing the earliest event video clip recorded during this whole hour.
	Event List	Click to enter the quick search menu for specific record data search, or select FULL to show all event logs.
	Repeat	Click to set point A and point B in a video clip, and the system will play only the specified range in that clip.
	Backup	Click to open the backup menu for video backup.

5. FREQUENTLY-USED FUNCTIONS

5.1 IP Device Search

On the recorder’s live view, choose **MENU → CAMERA → CONNECTION** to go to the setting page. For the channel to which you want to connect the IP camera, change the interface from **COAXIAL** to **IPCAM**.

CONNECTION												
CHANNEL TITLE	INTERFACE	EDIT	<input type="checkbox"/> ENABLE	URI	PORT	DEVICE TYPE	VENDOR	MODEL	STREAM PROTOCOL	METHOD	PATH1	PATH2
CH1	IPCAM			<input type="checkbox"/>	192.168.1.11	88	IPCAM	AVTECH	RTP-Unicast	TCP		
CH2	IPCAM			<input type="checkbox"/>								
CH3	COAXIAL			<input type="checkbox"/>								
CH4	COAXIAL			<input type="checkbox"/>								

Choose **IP SEARCH** to go to the **IP SEARCH** page directly and start searching the connected IP cameras.

You’ll see the list of every connected IP camera with its connection status to this device and MAC address. Click to assign the camera to the channel automatically and choose **ADD** to complete.

IP SEARCH										
ASSIGN	EDIT	DEVICE TYPE	IP	NETMASK	GATEWAY	PRIMARY DNS	PORT	MAC	VENDOR	
<input type="checkbox"/>		IPCAM	192.168.1.11	255.255.255.0	192.168.1.1	8.8.8.8	88	00:0E:53:31:06:E5	AVTECH	
<input type="checkbox"/>		IPCAM	192.168.1.11	255.255.255.0	0.0.0.0	8.8.8.8	88	00:0E:53:31:06:E5	ONVIF	
<input type="checkbox"/>		IPCAM	192.168.1.12	255.255.255.0	192.168.1.1	8.8.8.8	88	00:0E:53:31:15:D1	AVTECH	
<input type="checkbox"/>		IPCAM	192.168.1.12	255.255.255.0	0.0.0.0	8.8.8.8	88	00:0E:53:31:15:D1	ONVIF	

Make sure the IP address of the connected camera is in the network segment the same as your router uses. If not:



- For our brand’s IP camera, select and change the network type from **STATIC** to **DHCP**. Then, click **APPLY** to save your changes.

SETUP	
NETWORK TYPE	DHCP <input type="button" value="v"/>
IP	192.168.1.11
PORT	88
USER NAME	admin
PASSWORD	*****
NETMASK	255.255.255.0
GATEWAY	192.168.1.1
PRIMARY DNS	8.8.8.8
<input type="button" value="CANCEL"/> <input type="button" value="APPLY"/>	

- For other brand’s IP camera, please check its user manual to manually change its IP address.

5.2 User Account Creation

To create different user account for different access privilege, go to **MENU → ACCOUNT → USER LIST**, and choose  to create a new account.

USER LIST		USER LIST		
GROUP	EDIT	USER NAME	GROUP	
	 	admin	SUPERVISOR	
				

Four user levels are pre-defined in the system for you to quickly choose: SUPERVISOR, POWER USER, USER & GUEST.











Note: You can also customize a user level based on your needs by going to **MENU → ACCOUNT → GROUP**. For details, please go to "6.7.2 GROUP" at page 47.

Function	User Level			
	SUPERVISOR	POWER USER	USER	GUEST
■ GENERAL				
BACKUP	✓	✓		
PTZ CONTROL	✓	✓		
POWER CONTROL	✓			
REVIEW LOG	✓			
CONFIG SETUP	✓			
CLEAR LOG	✓			
ACCOUNT SETUP	✓			
CLEAR HDD	✓			
PUSH VIDEO	✓			
PUSH STATUS	✓			
ALARM OUT	✓	✓		
■ LOCAL				
LIVE VIDEO	✓	✓	✓	✓
LIVE AUDIO	✓	✓	✓	
PLAYBACK VIDEO	✓	✓		
PLAYBACK AUDIO	✓	✓		
■ NETWORK				
LIVE VIDEO	✓		✓	✓
LIVE AUDIO	✓		✓	
PLAYBACK VIDEO	✓			
PLAYBACK AUDIO	✓			

5.3 PTZ Control





	Enter	Click to confirm your selection / enter the menu.
	Up / Down / Left / Right	Click the arrow keys (▲ / ▼ / ◀ / ▶) to more the camera lens up / down / left /right.
	PAN / TILT	Click and drag the slider to move the camera lens vertically or horizontally.
Camera Control		
	Iris + / Iris -	These two buttons are designed for the PTZ camera which uses Pelco-D to control. To know the actions after clicking Iris + and Iris -, please refer to the camera's user manual.
	Focus near / far	Click to adjust the focus of the image.
	Zoom in / out	Click to zoom in / out on the image. Users could also zoom in / out on the image by simply drawing a square on the screen, and the zoom ratio depends on how large the square is. <ul style="list-style-type: none"> ■ Zoom in: Draw the square from top left to bottom right. ■ Zoom out: Draw the square from bottom right to left top.
	Zoom in / out max	Click to zoom in on the image to the largest / zoom out on the image to its original size.
	Auto mode	Click to activate the auto function. Before using it, you need to assign a specific function that will be enabled when is clicked. For details, please refer to the user manual of the camera.
	Auto tracking	Click to start auto tracking when your speed dome camera supports this function.
	Hot point	Click on the screen to move and center the camera view to the point you just clicked.
	Config.	Click to configure the speed to pan / tilt the speed dome camera.
	Joystick	Click to control the movement of a speed dome camera or a motorized-pan camera. Drag and hold the mouse on the screen to move the camera. You'll see ● and ● on the screen. The farther these two icons, the faster the movement.

 Preset Point		
01 ~ 10	Preset point 01 ~ 10	These ten buttons are used for preset point 1 ~ 10. To set or go to other preset point (such as 15), please enter the numbering manually in the input box next to  , and choose  to set the preset point, or  to go to the preset point.
	Set preset point	Move the camera view to the point you want to set, and click the numbering you want from 01 ~ 10, or enter the numbering manually in the input box next to  . Then, click  to confirm.
	Go to preset point	To go to the preset point from 1 ~ 10, simply click the button. To go to the other preset point out of 10, enter the numbering manually in the input box next to  , and choose  to confirm.

















































5.4 Video Backup

Note: Before using the USB flash drive, please use your PC to format the USB flash drive to FAT32 format first. For the list of compatible USB flash drives, please refer to "APPENDIX 3 COMPATIBLE USB FLASH DRIVE LIST at page 72.

Note: For video backup, please use USB flash drive or back your data up over the Internet. It's **NOT** allowed to connect the hard disk to your PC and get the video data directly.

To copy recorded data for video backup, click  to go to the playback panel, and choose  at the bottom tool bar to open the backup menu:

BACKUP

<p>SOURCE</p> <p>DATA TYPE <input checked="" type="checkbox"/> VIDEO <input type="checkbox"/> LOG</p> <p>RANGE 2017/07/18 23:03:52 ~ 2017/07/18 23:03:52</p> <table border="1" style="width: 100%; text-align: center;"> <tr> <td>< 2017 ></td> <td>SUN</td> <td>MON</td> <td>TUE</td> <td>WED</td> <td>THU</td> <td>FRI</td> <td>SAT</td> </tr> <tr> <td></td> <td></td> <td></td> <td></td> <td></td> <td></td> <td></td> <td>1</td> </tr> <tr> <td></td> <td>2</td> <td>3</td> <td>4</td> <td>5</td> <td>6</td> <td>7</td> <td>8</td> </tr> <tr> <td></td> <td>9</td> <td>10</td> <td>11</td> <td>12</td> <td>13</td> <td>14</td> <td>15</td> </tr> <tr> <td>< JUL ></td> <td>16</td> <td>17</td> <td>18</td> <td>19</td> <td>20</td> <td>21</td> <td>22</td> </tr> <tr> <td></td> <td>23</td> <td>24</td> <td>25</td> <td>26</td> <td>27</td> <td>28</td> <td>29</td> </tr> <tr> <td></td> <td>30</td> <td>31</td> <td></td> <td></td> <td></td> <td></td> <td></td> </tr> </table> <p style="text-align: center;">< 23:03:52 > HR MIN SEC</p> <p style="text-align: right;">HOURS</p> <p>CHANNEL <input type="checkbox"/> ALL</p> <table border="1" style="width: 100%; text-align: center;"> <tr> <td>CH1</td><td>CH2</td><td>CH3</td><td>CH4</td> </tr> <tr> <td> <input checked="" type="checkbox"/></td><td> <input type="checkbox"/></td><td> <input checked="" type="checkbox"/></td><td> <input type="checkbox"/></td> </tr> <tr> <td>CH5</td><td>CH6</td><td>CH7</td><td>CH8</td> </tr> <tr> <td> <input type="checkbox"/></td><td> <input type="checkbox"/></td><td> <input type="checkbox"/></td><td> <input type="checkbox"/></td> </tr> <tr> <td>CH9</td><td>CH10</td><td>CH11</td><td>CH12</td> </tr> <tr> <td> <input type="checkbox"/></td><td> <input type="checkbox"/></td><td> <input type="checkbox"/></td><td> <input type="checkbox"/></td> </tr> <tr> <td>CH13</td><td>CH14</td><td>CH15</td><td>CH16</td> </tr> <tr> <td> <input type="checkbox"/></td><td> <input type="checkbox"/></td><td> <input type="checkbox"/></td><td> <input type="checkbox"/></td> </tr> </table>	< 2017 >	SUN	MON	TUE	WED	THU	FRI	SAT								1		2	3	4	5	6	7	8		9	10	11	12	13	14	15	< JUL >	16	17	18	19	20	21	22		23	24	25	26	27	28	29		30	31						CH1	CH2	CH3	CH4	 <input checked="" type="checkbox"/>	 <input type="checkbox"/>	 <input checked="" type="checkbox"/>	 <input type="checkbox"/>	CH5	CH6	CH7	CH8	 <input type="checkbox"/>	 <input type="checkbox"/>	 <input type="checkbox"/>	 <input type="checkbox"/>	CH9	CH10	CH11	CH12	 <input type="checkbox"/>	 <input type="checkbox"/>	 <input type="checkbox"/>	 <input type="checkbox"/>	CH13	CH14	CH15	CH16	 <input type="checkbox"/>	 <input type="checkbox"/>	 <input type="checkbox"/>	 <input type="checkbox"/>	<p>DESTINATION</p> <p>TARGET USB DEVICE <input checked="" type="checkbox"/></p> <p>AVAILABLE SIZE 3 GB</p> <p>STORAGE</p> <p>USB PATH <input type="text" value="/VIDEO"/> ...</p> <table border="1" style="width: 100%; text-align: center;"> <thead> <tr> <th>TIME</th> <th>CHANNEL</th> <th>BACKUP TYPE</th> <th>DEVICE</th> <th>STATUS</th> </tr> </thead> <tbody> <tr><td> </td><td> </td><td> </td><td> </td><td> </td></tr> <tr><td> </td><td> </td><td> </td><td> </td><td> </td></tr> <tr><td> </td><td> </td><td> </td><td> </td><td> </td></tr> <tr><td> </td><td> </td><td> </td><td> </td><td> </td></tr> <tr><td> </td><td> </td><td> </td><td> </td><td> </td></tr> <tr><td> </td><td> </td><td> </td><td> </td><td> </td></tr> <tr><td> </td><td> </td><td> </td><td> </td><td> </td></tr> <tr><td> </td><td> </td><td> </td><td> </td><td> </td></tr> <tr><td> </td><td> </td><td> </td><td> </td><td> </td></tr> <tr><td> </td><td> </td><td> </td><td> </td><td> </td></tr> <tr><td> </td><td> </td><td> </td><td> </td><td> </td></tr> <tr><td> </td><td> </td><td> </td><td> </td><td> </td></tr> <tr><td> </td><td> </td><td> </td><td> </td><td> </td></tr> <tr><td> </td><td> </td><td> </td><td> </td><td> </td></tr> <tr><td> </td><td> </td><td> </td><td> </td><td> </td></tr> <tr><td> </td><td> </td><td> </td><td> </td><td> </td></tr> </tbody> </table> <p style="text-align: right;"> <input type="button" value="CANCEL"/> <input type="button" value="BACKUP"/> </p>	TIME	CHANNEL	BACKUP TYPE	DEVICE	STATUS																																																																																
< 2017 >	SUN	MON	TUE	WED	THU	FRI	SAT																																																																																																																																																																							
							1																																																																																																																																																																							
	2	3	4	5	6	7	8																																																																																																																																																																							
	9	10	11	12	13	14	15																																																																																																																																																																							
< JUL >	16	17	18	19	20	21	22																																																																																																																																																																							
	23	24	25	26	27	28	29																																																																																																																																																																							
	30	31																																																																																																																																																																												
CH1	CH2	CH3	CH4																																																																																																																																																																											
 <input checked="" type="checkbox"/>	 <input type="checkbox"/>	 <input checked="" type="checkbox"/>	 <input type="checkbox"/>																																																																																																																																																																											
CH5	CH6	CH7	CH8																																																																																																																																																																											
 <input type="checkbox"/>	 <input type="checkbox"/>	 <input type="checkbox"/>	 <input type="checkbox"/>																																																																																																																																																																											
CH9	CH10	CH11	CH12																																																																																																																																																																											
 <input type="checkbox"/>	 <input type="checkbox"/>	 <input type="checkbox"/>	 <input type="checkbox"/>																																																																																																																																																																											
CH13	CH14	CH15	CH16																																																																																																																																																																											
 <input type="checkbox"/>	 <input type="checkbox"/>	 <input type="checkbox"/>	 <input type="checkbox"/>																																																																																																																																																																											
TIME	CHANNEL	BACKUP TYPE	DEVICE	STATUS																																																																																																																																																																										

Step1: In **SOURCE**, choose the data type (**VIDEO** or **LOG**) and the time range you want to copy from the calendar. The date with video recording will be shown in blue.

Step2: In **CHANNEL**, choose the channel(s) you want.

Step3: In **DESTINATION**, choose where you want to save the data, in a USB flash drive (**USB DEVICE**) or on FTP (**FTP**).

Step4: (Optional) When **USB DEVICE** is chosen, specify the directory in **STORAGE** if needed.

Step5: Choose **BACKUP** to start. The backup video will be in the AVI format.

Note: You can also go to **MENU** → **EXPORT** → **BACKUP** to check backup logs or click  on the top to enter the backup page.

Note: When the video compression format is H.265, please use the video player which supports H.265 to play the video footage.

5.5 System Logout

When different user accounts are created for system management, make sure you log out after your access in case other people access the system with your account.

Choose **MENU** → **POWER CONTROL**, and choose  to log out the system.

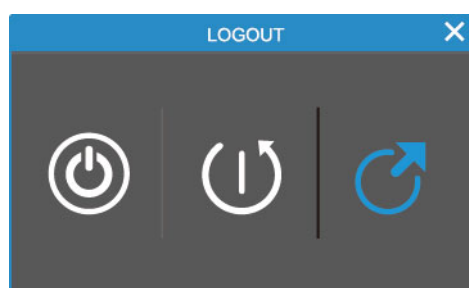

Note: The default user name and password are both **admin**, which is the highest user level.

5.6 Hardware Reset

When you forget the access user name and / or password, this will show you how to reset your recorder to its factory default values. Your recorder supports only either of the methods mention below depending on the model you have.

Method 1: Reset button

Step 1: Power off your recorder.

Step 2: Open the top cover of the recorder to reveal the main board, and find a **blue** button on the board. It's the hardware reset button.

Step 3: Press and hold the blue button, and power on your recorder at the same time. Release the button when you hear the second beep sound. You'll see the reset message on the screen.

Method 2: Reset pins

Step 1: Power off your recorder.

Step 2: Remove the top cover of the recorder and find the board attached to the front panel as shown below.

Step 3: Find the cable with a pin terminal block connected to the board.

Step 4: Get a paper clip (or forceps) and insert the two sides of it respectively to the 2nd and 4th pinpoints as shown below.

Step 5: With the paper clip inserted, power on your recorder at the same time. Wait till you hear the beep sound and you see the reset message on the screen.

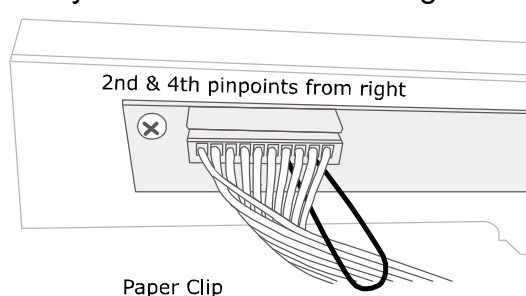

6. MAIN MENU

6.1 CAMERA

6.1.1 CONNECTION

This menu is used to add an IP camera to the recorder when your recorder supports this function.

Note: Please check the specifications of your device to know if your recorder supports IP camera connections.

Before connecting an IP camera, make sure its IP address will be in the same network segment as the one your router uses.

For the channel to which you want to connect the IP camera, change the interface from **COAXIAL** to **IPCAM**. Then, choose **IP SEARCH** to enter the IP search page. You'll see the list of all connected IP cameras for you to choose. For details, please check "IP Camera" at page 6 for details.

CONNECTION												
CHANNEL TITLE	INTERFACE	EDIT	<input type="checkbox"/> ENABLE	URI	PORT	DEVICE TYPE	VENDOR	MODEL	STREAM PROTOCOL	METHOD	PATH1	PATH2
CH1	IPCAM		<input type="checkbox"/>	192.168.1.11	88	IPCAM	AVTECH		RTP-Unicast	TCP		
CH2	IPCAM		<input type="checkbox"/>	192.168.1.12	82	IPCAM	ONVIF		RTP-Unicast	TCP		
	COAXIAL		<input type="checkbox"/>									
	COAXIAL		<input type="checkbox"/>									
										BATCH	IP SEARCH	

6.1.2 DEVICE

DEVICE													
CHANNEL TITLE	ENABLE	CACHE TIME (MSEC)	PORT FORWARD	CAMERA TYPE	ALARM OUT	OSD TITLE	OSD LOGO						
CH1			81	AUTO	3	UP LEFT	UP LEFT						
CH2			82	AUTO	3	UP LEFT	UP LEFT						
CH3			83	AUTO	3	UP LEFT	UP LEFT						
CH4			84	AUTO	3	UP LEFT	UP LEFT						
												APPLY	



1) CHANNEL TITLE

Click to revise the channel title (up to 63 characters). The default title is the channel number.

2) ENABLE

Here shows the functions you can enable or disable:

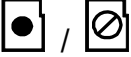
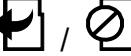
Note: The icons available depend on the camera you connected.

Icon	Meaning	Description
	Time stamp on / off	Display the recording time or not.
	Edge recording on / off	Enable this function to allow video recording directly to the microSD card inserted in the IP camera when the recorder is disconnected to the camera and unable to work properly.
	Recording transfer on / off	When edge recording is on, enable this function to allow the video saved in the microSD card of the camera transferring to the recorder when the recorder is reconnected to the camera and work properly.
	Audio recording on / off	Enable or disable audio recording for the selected channel if the connected camera supports audio recording.

3) CACHE TIME (MSEC)

Drag the slide bar to change the cache time which determines the buffering time of playback.

Note: To speed up the camera's operation, especially for the PTZ camera, you may set the CACHE TIME (MSEC) as zero, but this change may debase the transmission quality.

4) PORT FORWARD *(available for IP camera only)*

This function is used when you only want to see a single channel of this recorder remotely.

a) Set the port number for the channel in **PORT FORWARD**. The default value for CH1 is 81, and the default value for CH2 is 82... etc. If you want to change the port number to other value, the range is from 1 ~ 65535.

b) Switch to to enable port forwarding.

The address of the channel will be "**http://recorder_address:port_number**". Enter the address in Internet Explorer, and see if you can access the device connected channel individually.

Note: The user name and password are still required to access the device connected to the channel. Make sure you know the user name and password to access the device. For details, please refer to its user manual.

5) CAMERA TYPE

Here shows the camera type which is detected automatically.

6) ALARM OUT *(Depending on the camera you connected)*

This function is used to set how long the device should work in seconds when the  is clicked on the camera channel.

Note: An alarm-out device (such as a buzzer) should be connected to the camera first for this function to take effects.

7) OSD TITLE

Choose to display the name of the channel or not, and decide where to show it (UP LEFT / UP MIDDLE / UP RIGHT / DOWN LEFT / DOWN MIDDLE / DOWN RIGHT). The display of the title will not disappear in the backup footage.

8) OSD LOGO

This function is reserved for future use.

5.1.3 IMAGE





















Click  to manually adjust the brightness / contrast / saturation / hue by channel.

IMAGE					
EDIT	CHANNEL TITLE	BRIGHTNESS	CONTRAST	SATURATION	HUE
	CH1	128	128	140	128
	CH2	128	128	140	128
	CH3	128	128	140	128
	CH4	128	128	140	128

6.1.4 DETECTION

DETECTION							
CHANNEL TITLE	ALARM	INTERNAL ALARM	SENSITIVITY	MOTION	AREA	ADVANCED CONFIG	
CH1	OFF <input type="checkbox"/>	<input checked="" type="checkbox"/>	ON	EDIT	ON	EDIT	   
CH2	N.C. <input type="checkbox"/>	<input checked="" type="checkbox"/>	OFF	EDIT	OFF	EDIT	   
CH3	N.O. <input type="checkbox"/>	<input checked="" type="checkbox"/>	OFF	EDIT	OFF	EDIT	   
CH4	OFF <input type="checkbox"/>	<input checked="" type="checkbox"/>	OFF	EDIT	OFF	EDIT	   
							APPLY

1) ALARM

Select **N.C.** / **N.O.** depending on your installation need. The default alarm value is **OFF**.

Note: This option is available only when the camera you connected supports alarm I/O connection and an alarm sensor is connected directly to the camera. If the alarm sensor is connected to the recorder, please check "6.11.3 LOCAL ALARM IN" at page 53 for details.

2) INTERNAL ALARM

Select if you want to activate the PIR detection function for the selected channel (**ON** / **OFF**).

Note: This option is available only when the camera you connected has a PIR sensor built-in.

3) SENSITIVITY

For analog camera, click **EDIT** to set LS / SS / TS.

Function	Description
LS (Level of Sensitivity)	LS is to set the sensitivity of comparing two different images. The smaller the value is, the higher sensitivity for motion detection. The highest sensitivity setting is 00, and the lowest sensitivity setting is 15. The default value is 07 .
SS (Spatial Sensitivity)	SS is to set the sensitivity for detecting the size of one object (the number of the grids) on the screen. The smaller the value is, the higher sensitivity for motion detection. The highest sensitivity setting is 00, and the lowest sensitivity setting is 15. The default setting is 03 . Note: The default setting of SS is 03, which means once an object is detected more than 3 grids, the system will get triggered. So the value of SS must be less than the number of grids that you set up for the motion detection area.
TS (Time of Sensitivity)	TS is to set the sensitivity regarding how long one object stays in the detection area and triggers the recording. The smaller the value is, the higher sensitivity for motion detection. The highest sensitivity setting is 00, and the lowest sensitivity setting is 15. The default setting is 02 .

For IP camera, select the detection sensitivity of the selected channel. **2** is the highest sensitivity.

4) MOTION

Select if you want to activate the motion detection function for the selected channel (**ON / OFF**).

5) AREA

Click **EDIT** to set the motion detection area.

There are 16 × 12 grids per camera for all channels. Pink blocks represent the area that is not being detected while the transparent blocks are the area under detection.

Note: To exit area setting and return to the detection page, right click your mouse.

6) ADVANCED CONFIG

The advanced settings are available only when the connected camera supports.



■  Video Analytics

The options within this function should work with CMS PRO to take effects. For details, please check with your installer or distributor.

PRIVACY MASK	
SCENE CHANGE	OFF
DEFOCUS	OFF
ENABLE OBJECT DETECTION	OFF
ENABLE FACE DETECTION	OFF
<input type="button" value="APPLY"/>	

■  Privacy mask

You can cover certain areas on the camera image with privacy masks. Up to 20 areas could be added.

PRIVACY MASK					
MOSAIC SIZE					8x8
NAME	FUNCTION	MOSAIC	COLOR	MOSAIC COLOR	TRANSPARENCY
MASK1	OFF	OFF	ON		0%
MASK2	ON	ON	ON		25%
				<input type="button" value="ADD"/>	<input type="button" value="EDIT"/>
				<input type="button" value="DEL"/>	

Select **ADD** to add a new setting, **EDIT** to modify an existing setting, and **DEL** to remove a setting.

PRIVACY MASK - EDIT	
NAME	MASK3
FUNCTION	ON
MOSAIC	ON
COLOR	ON
MOSAIC COLOR	
TRANSPARENCY	50%
MASK AREA	SETUP

Item	Description
MOSAIC SIZE	Choose the mosaic size of the privacy mask. The options are: 8x8 , 32x32 , and 64x64 .
NAME	Name your privacy mask.
FUNCTION	Select ON to enable the privacy mask function.
MOSAIC	Select ON to have the mosaic effect.
COLOR	Select ON to color the privacy mask. In the meantime, you can't see the mosaic effect.
COLOR FOR MASK	Select the color for the privacy mask.
TRANSPARENCY	Select the transparency for your privacy mask. The options are: 0% , 25% , 50% , and 100% . When 100% is chosen, no color is shown but only the mosaic effect for the mask area.
LINE WIDTH	Select if you want to know where the mask area is especially when the transparency is set to 100% . This function will add a border for the mask area. The options are: 0 , 2 , 4 and 6 . When 0 is chosen, no border is added.
MASK AREA	Select SETUP to enter the area selection page. To exit, right click.

■ **ROI** ROI (Region of Interest)

ROI is used to reinforce the image quality of the selected area(s). Users could specify two areas in the camera view.

REGION OF INTEREST		
REGION	ENABLE	QUALITY
1	ON	7
2	OFF	7
		EDIT

- Select **REGION 1** or **REGION 2**, and choose **EDIT** to change the setting.

REGION OF INTEREST - EDIT	
ENABLE	ON
QUALITY	0 5 10 ■■■■■■■■■■ SETUP
AREA	
APPLY	

■  Camera Guard

This function is used to lock the camera to a fixed point and no pan action could be made until the lock mode is disabled. Before using this function, make sure:

1. You've configured at least one preset point and one preset group for the connected camera. To know how to configure preset points and preset group, please refer to "5.3 PTZ Control" at page 18.
2. You have an iOS or android mobile device with our free app, EagleEyes, installed.
3. Your recorder is connected to Internet, and registered in the address book of EagleEyes.

CAMERA GUARD - CH1		
GUARD LOCK	ON	
TIMEOUT (SECS)	30	▼
PRESET GROUP	1	▼
PRESET NUMBER	1	▼
APPLY		

Item	Description
GUARD LOCK	Enable (ON) or disable (OFF) this function.
TIMEOUT (SECS)	Configure the timeout in seconds (30 / 60 / 90 / 120) after which the camera will be fixed to the current point and any attempt to pan the camera to another point will be failed.
PRESET GROUP	Choose the group where the point you'd like to use is configured, and go to PRESET NUMBER to choose the preset point number.
PRESET NUMBER	Choose the preset point number you'd like to use when GUARD LOCK is enabled.

6.1.5 ALARM OUT

Note: An alarm-out device (such as a buzzer) should be connected to a camera first for this function to take effects. To configure the alarm-out device connected to the recorder itself, please refer to "6.11.4 LOCAL ALARM OUT" at page 53.

This function is used when the external alarm-out device is connected to a camera. You can configure an alarm-out device to activate continuously or activate only for a period of time when it's triggered.

In **RESTORE AUTOMATICALLY**,

- Choose **DISABLE** to allow the device to activate continuously when it's triggered unless you switch it off manually from the alarm-out switch control panel (🔊) on the live view.
- Choose **ENABLE** to allow the device to activate only for a period of time (**1 / 3 / 5 / 10 / 20 / 30 / 60 / 120 / 180** seconds) when it's triggered.

ALARM OUT				
CHANNEL TITLE	NAME	RESTORE AUTOMATICALLY	ALARM OUT DURATION (SECS)	
CH1	alarmout-ch1	DISABLE	1	▼
CH2	alarmout-ch2	ENABLE	5	▼
CH3				
CH4				
			APPLY	

6.2 RECORD

Set the image size, video quality and other related parameters individually for live display, record streaming and sub streaming.

Note: The settings shown below depend on the setting tab you selected in this setting page.

- a) **D.O.R** (Depend on record): When this option is checked, the video size, quality and other related parameters will follow the configurations in **RECORD STREAM**.
- b) **PROFILE**: Select the video profile pre-defined in your IP cameras. You can directly use the profile setting, or modify the setting on this page.
- c) **TYPE**: Select the compression format for each channel.

Note: The options selectable for **TYPE** depend on the camera you're intended to connect.

- d) **IMAGE SIZE**: Select the image size for each channel.

Note: The options selectable for **IMAGE SIZE** depend on the camera you're intended to connect.

- e) **QUALITY**: Select the video quality for each channel. The higher the value, the better the image quality.
- f) **I.P.S.**: Image per Second, the higher the value, the more fluent the video.

Note: The options selectable for "I.P.S." depends on the camera you're intended to connect.

- g) **BITRATE (kbps)**: Select how much data to process per unit of time for each channel. The higher the value, the better the video quality.
- h) **BITRATE CONTROL**: Configure the upper bit rate limit for the selected channel if necessary.
VBR - When the bit rate of the camera exceeds the value you set, the video fluency may be affected;
CBR - When the bit rate of the camera exceeds the value you set, the image quality may be affected.
- i) **G.O.V.**: "Group of VOPs" is used to configure the length of G.O.V. The greater of the value, the less the bandwidth for transmission, and the poorer the image quality.

■ LIVE (Available for IP cameras only)

VIDEO SOURCE CONFIG												
LIVE	RECORD STREAM	SUBSTREAM										
CHANNEL	D.O.R	PROFILE	TYPE		IMAGE SIZE	QUALITY	I.P.S.	BITRATE (kbps)	BITRATE CONTROL	G.O.V.		
CH1	<input type="checkbox"/>	PROFILE-3	✓	H265	✓	720 X 480		30	✓	2048	VBR	30
CH2	<input type="checkbox"/>	PROFILE-3	✓	H264	✓	1280 x 1024		30	✓	2048	VBR	30
CH3	<input type="checkbox"/>	PROFILE-3	✓	H264	✓	1280 x 1024		30	✓	2048	VBR	30
CH4	<input type="checkbox"/>	PROFILE-3	✓	H264	✓	1280 x 1024		30	✓	2048	VBR	30
											APPLY	

■ RECORD STREAM

VIDEO SOURCE CONFIG											
LIVE	RECORD STREAM	SUBSTREAM									
PROFILE-1		✓									
CHANNEL	PROFILE	TYPE		IMAGE SIZE	QUALITY	I.P.S.	BITRATE (kbps)	BITRATE CONTROL	G.O.V.		
CH1	PROFILE-3	✓	H265	✓	720 X 480		30	✓	2048	VBR	30
CH2	PROFILE-3	✓	H264	✓	1280 x 1024		30	✓	2048	VBR	30
CH3	PROFILE-3	✓	H264	✓	1280 x 1024		30	✓	2048	VBR	30
CH4	PROFILE-3	✓	H264	✓	1280 x 1024		30	✓	2048	VBR	30
											APPLY















■ SUB STREAM

VIDEO SOURCE CONFIG											
LIVE	RECORD STREAM	SUBSTREAM									
CHANNEL	PROFILE	TYPE		IMAGE SIZE	QUALITY	I.P.S.	BITRATE (kbps)	BITRATE CONTROL	G.O.V.		
CH1	PROFILE-3	✓	H265	✓	720 X 480		30	✓	2048	VBR	30
CH2	PROFILE-3	✓	H264	✓	1280 x 1024		30	✓	2048	VBR	30
CH3	PROFILE-3	✓	H264	✓	1280 x 1024		30	✓	2048	VBR	30
CH4	PROFILE-3	✓	H264	✓	1280 x 1024		30	✓	2048	VBR	30
											APPLY

6.3 SCENARIO

This function allows you to customize a series of actions which will be run automatically after the specified event occurs.

Several scenario rules are pre-defined for you to quickly choose and apply. If none of these rules are suitable for you, you can choose  to create your own rule from several scenario templates.

SCENARIO					
EDIT	NAME	TRIGGER	ACTION	TIMER	STATUS
 	MOTION RECORD	ALL CHANNELS	START RECORDING EVENT CHANNEL		OFF
 	ALARM RECORD	ALL CHANNELS	START RECORDING EVENT CHANNEL		OFF
 	GUARD RECORD	GUARD	START RECORDING ALL CHANNELS		ON
 	PUSH VIDEO NOTIFICATIONS (PIR)	GUARD,MOTION(CH1), PIR(CH1)...	PUSH VIDEO TO SEE PLAYBACK		ON
 	PUSH VIDEO NOTIFICATIONS (ALARM)	GUARD,MOTION(CH1),ALARM(CH1)...	PUSH VIDEO TO SEE PLAYBACK		ON
 	MANUAL RECORD		START RECORDING ALL CHANNELS	EVERYDAY	ON
 	PUSH STATUS	ALL SYSTEM STATUSES	PUSH STATUS	EVERYDAY	ON
 	EVENT POP-UP ON LIVE MONITOR (MOTION & ALARM)	MOTION(ALL CHANNELS),ALARM(ALL CHANNELS)	POP UP EVENT ON LIVE MONITOR		ON
 	GUARD ON (MOTION DETECTION)	GUARD			ON
 	GUARD ON (PIR DETECTION)	GUARD			ON
 	GUARD OFF (MOTION DETECTION)	GUARD			ON
 	GUARD OFF (PIR DETECTION)	GUARD			ON
 	EVENT POP-UP ON EVENT MONITOR (MOTION & ALARM)	MOTION(ALL CHANNELS),ALARM(ALL CHANNELS)	PLAYBACK VIDEO ON EVENT MONITOR		ON
					

6.3.1 Pre-defined Scenarios

The pre-defined scenarios are created for you to quickly enable the recording and notification functions which are used frequently. The available scenarios depend on the models you have.

Note: All pre-defined scenarios are not editable. If any changes should be made to suit your need, please add a scenario rule manually.

1) MOTION RECORD

All channels are selected in this rule. The recorder starts recording the channel which has a motion event. Scenario template used: **ONE OF (EVENT) TO (RECORD)**.

2) ALARM RECORD

All channels are selected in this rule. The recorder starts recording the channel which has an alarm event. Scenario template used: **ONE OF (EVENT) TO (RECORD)**.

Note: The alarms here refer to the alarm devices connected to the cameras or the recorder. For the alarm events triggered by the PIR sensor built into the camera, please choose PIR instead.

3) GUARD RECORD

When **Guard** is enabled from EagleEyes, our mobile app, the recorder starts recording all channels. Scenario template used: **ONE OF (EVENT) TO (RECORD)**.

4) PUSH VIDEO TRIGGERED BY BUILT-IN PIR SENSOR

When motion & PIR events occur simultaneously, you'll receive Push Video on your mobile device. Scenario template used: **ALL OF (EVENTS) TO DO (ACTION) AND THEN (ACTION)**.

Note: To know how to enable Push Video, please refer to "4CH Models

	Model 12	Model 13	Model 14
▼ Video			

Video System		NTSC / PAL (auto detection)	
Video Compression Format		H.265	
Video Signal		IP / TVI / CVI / Analog HD / 960H	
Video Input		4 pentabrid channels, within which IP channels are up to 4 channels	4 pentabrid channels, within which IP channels are up to 2 channels
Video Input Interface	Analog Mode	Composite video signal 1 Vp-p 75Ω BNC	
	IP Mode	Ethernet, 1000 Base-T	
Video Output	BNC	YES (1080P display)	
	VGA	YES (1080P display)	YES (1080P display / unavailable when video display is set to 4K2K)
	HDMI	YES (4K2K display)	
Video Resolution	Analog Mode	5MP / 5MLITE / 4MP / 4MLITE / FHD (1080P) / HD / 960H / Frame / CIF	
	IP Mode	2592 x 1944 / 2048 x 1536 / 1920 x 1080 / 1280 x 720 / 720 x 480 / 352 x 240	
▼ Record & Backup			
Max. Recording Rate	Analog Mode	Up to 24 IPS @ 5MP Up to 32 IPS @ 4MP Up to 60 IPS @ FHD (1080P)	
	IP Mode	UP to 28 IPS @ 5MP UP to 40 IPS @ 3MP UP to 60 IPS @ 1080P	UP to 30 IPS @ 5MP UP to 50 IPS @ 3MP UP to 60 IPS @ 1080P
Recording Mode	Manual / Timer / Motion / Alarm / Remote		
Playback Channel	4CH		
Quick Search	Time / Motion / Alarm search mode		
Backup Device	USB 2.0 drive / Network		
Regular Backup	YES (USB hard drive or FTP)		
▼ Audio			
Audio Input	4		
Audio Output (Mono)	1		
▼ External I/O			
RS485	YES		
Alarm Input	4		
Alarm Output	1		
▼ General			
Hard Disk Storage	14TB SATA HDD x 1 or external disk array x 1 connected to the recorder via the eSATA interface		
SATA Interface	YES		
eSATA Interface	Expandable with a SATA to eSATA cable		
Image Quality Setting	SUPER BEST / BEST / HIGH / NORMAL		
USB Mouse Control	YES		
Motion Detection Area	16 × 12 grids per channel		
Motion Detection Sensitivity	3 adjustable parameters for accurate detection		
Event Notification	Push Video / Push Status / FTP / E-Mail		
Event Pop-up & Preview	YES		
Scenario Setup	YES		
Picture Zoom	2X digital zoom		
PTZ Control	YES		

	Model 12	Model 13	Model 14
▼ General			
Key Lock (Password Protection)	YES		

User Level	4 user levels for different access privilege		
Video Loss Detection	YES		
Camera Title	Supports up to 25 letters		
Video Adjustable	Hue / Saturation / Contrast / Brightness		
Date Display Format	YY/MM/DD, DD/MM/YY & MM/DD/YY		
Daylight Saving	YES		
Power Source (±10%)	12V / 2A		
Operating Temperature	10°C ~ 40°C (50°F~104°F)		
Operating Humidity	10% ~ 85%		
Dimensions (mm)**	260 x 235.7 x 48		
Net Weight (kg)	1.3		
▼ Network			
Ethernet	1000 Base-T. Supports remote control and live view via Ethernet		
Network Protocol	TCP/IP, PPPOE, DHCP and DDNS		
▼ Remote Surveillance from PC			
Compatible Operating System	Windows & MAC		
Compatible Program	Web Browser:	Windows Edge, Internet Explorer, Google Chrome, Safari & Mozilla Firefox	
	CMS Lite:	32CH central management software for Windows OS	
Max. online users	20		
Web Transmitting Compression Format	H.265		
Network Live Audio	YES		
Remote Event Download & Playback	YES		
▼ Mobile Surveillance			
App	EagleEyes		
Compatible Devices	iOS & Android mobile devices		
Push Video	4CH	1CH	4CH
Push Status	YES		
▼ Others			
EaZy Networking	YES		
IVS	4 channels in analog mode	NO	
Spot Monitor Setup	NO		
DCCS Support	YES		
Free DDNS service	YES		
Privacy Mask	YES		
Multiplex Operation	Live display / record / playback / backup / network operations		
System Recovery	System auto recovery after power failure		
Optional Peripherals	HDMI Matrix (HDM02) / USB Joystick (AVX102) / SATA to eSATA cable (PWSC07F120200)		

* The specifications are subject to change without notice.

** Dimensional tolerance: ±5mm

APPENDIX 2 PUSH VIDEO CONFIGURATION at page 67.

5) PUSH VIDEO TRIGGERED BY EXTERNAL ALARM

When motion & alarm events occur simultaneously, you'll receive Push Video on your mobile device.

Scenario template used: **ALL OF (EVENTS) TO DO (ACTION) AND THEN (ACTION).**

Note: The alarms here refer to the alarm devices connected to the cameras or the recorder. For the alarm events triggered by the PIR sensor built into the camera, please choose PIR instead.

Note: To know how to enable Push Video, please refer to "4CH Models

		Model 12	Model 13	Model 14
▼ Video				
Video System		NTSC / PAL (auto detection)		
Video Compression Format		H.265		
Video Signal		IP / TVI / CVI / Analog HD / 960H		
Video Input		4 pentabrid channels, within which IP channels are up to 4 channels	4 pentabrid channels, within which IP channels are up to 2 channels	
Video Input Interface	Analog Mode	Composite video signal 1 Vp-p 75Ω BNC		
	IP Mode	Ethernet, 1000 Base-T		
Video Output	BNC	YES (1080P display)		
	VGA	YES (1080P display)	YES (1080P display / unavailable when video display is set to 4K2K)	
	HDMI	YES (4K2K display)		
Video Resolution	Analog Mode	5MP / 5MLITE / 4MP / 4MLITE / FHD (1080P) / HD / 960H / Frame / CIF		
	IP Mode	2592 x 1944 / 2048 x 1536 / 1920 x 1080 / 1280 x 720 / 720 x 480 / 352 x 240		
▼ Record & Backup				
Max. Recording Rate	Analog Mode	Up to 24 IPS @ 5MP Up to 32 IPS @ 4MP Up to 60 IPS @ FHD (1080P)		
	IP Mode	UP to 28 IPS @ 5MP UP to 40 IPS @ 3MP UP to 60 IPS @ 1080P	UP to 30 IPS @ 5MP UP to 50 IPS @ 3MP UP to 60 IPS @ 1080P	
Recording Mode		Manual / Timer / Motion / Alarm / Remote		
Playback Channel		4CH		
Quick Search		Time / Motion / Alarm search mode		
Backup Device		USB 2.0 drive / Network		
Regular Backup		YES (USB hard drive or FTP)		
▼ Audio				
Audio Input		4		
Audio Output (Mono)		1		
▼ External I/O				
RS485		YES		
Alarm Input		4		
Alarm Output		1		
▼ General				
Hard Disk Storage		14TB SATA HDD x 1 or external disk array x 1 connected to the recorder via the eSATA interface		
SATA Interface		YES		
eSATA Interface		Expandable with a SATA to eSATA cable		
Image Quality Setting		SUPER BEST / BEST / HIGH / NORMAL		
USB Mouse Control		YES		
Motion Detection Area		16 × 12 grids per channel		

Motion Detection Sensitivity	3 adjustable parameters for accurate detection
Event Notification	Push Video / Push Status / FTP / E-Mail
Event Pop-up & Preview	YES
Scenario Setup	YES
Picture Zoom	2X digital zoom
PTZ Control	YES

	Model 12	Model 13	Model 14
▼ General			
Key Lock (Password Protection)	YES		
User Level	4 user levels for different access privilege		
Video Loss Detection	YES		
Camera Title	Supports up to 25 letters		
Video Adjustable	Hue / Saturation / Contrast / Brightness		
Date Display Format	YY/MM/DD, DD/MM/YY & MM/DD/YY		
Daylight Saving	YES		
Power Source (±10%)	12V / 2A		
Operating Temperature	10°C ~ 40°C (50°F~104°F)		
Operating Humidity	10% ~ 85%		
Dimensions (mm)**	260 x 235.7 x 48		
Net Weight (kg)	1.3		
▼ Network			
Ethernet	1000 Base-T. Supports remote control and live view via Ethernet		
Network Protocol	TCP/IP, PPPOE, DHCP and DDNS		
▼ Remote Surveillance from PC			
Compatible Operating System	Windows & MAC		
Compatible Program	Web Browser:	Windows Edge, Internet Explorer, Google Chrome, Safari & Mozilla Firefox	
	CMS Lite:	32CH central management software for Windows OS	
Max. online users	20		
Web Transmitting Compression Format	H.265		
Network Live Audio	YES		
Remote Event Download & Playback	YES		
▼ Mobile Surveillance			
App	EagleEyes		
Compatible Devices	iOS & Android mobile devices		
Push Video	4CH	1CH	4CH
Push Status	YES		
▼ Others			
EaZy Networking	YES		
IVS	4 channels in analog mode	NO	
Spot Monitor Setup	NO		
DCCS Support	YES		
Free DDNS service	YES		
Privacy Mask	YES		
Multiplex Operation	Live display / record / playback / backup / network operations		
System Recovery	System auto recovery after power failure		
Optional Peripherals	HDMI Matrix (HDM02) / USB Joystick (AVX102) / SATA to eSATA cable (PWSC07F120200)		

* The specifications are subject to change without notice.

** Dimensional tolerance: $\pm 5\text{mm}$

APPENDIX 2 PUSH VIDEO CONFIGURATION at page 67.

6) MANUAL RECORD

All channels are selected in this rule. The recorder starts recording all channels at the specified time.

Scenario template used: **START (RECORD) AT (TIME)**.

7) SEND PUSH STATUS FOR HEALTH CHECK

All system health events are selected in this rule. When one of the health events occurs at the specified time range, you'll receive Push Status on your mobile device.

Scenario template used: **ONE OF (HEALTH EVENT) OCCURRED AT (TIME) TO SEND PUSH STATUS**.

8) POP-UP ON LIVE MONITOR (MOTION AND EXTERNAL ALARM EVENT)

All channels are selected in this rule. When any motion or alarm event occurs, you'll see pop-up messages on the right pane (Event List) of the monitor.

Scenario template used: **ONE OF (EVENT) TO DO (ACTION)**.

Note: The alarms here refer to the alarm devices connected to the cameras or the recorder. For the alarm events triggered by the PIR sensor built into the camera, please choose PIR instead.

9) MOTION DETECTION ON WHEN GUARD ON

All channels are selected in this rule. When **Guard** is enabled from EagleEyes, our mobile app, the motion detection of all channels is also enabled automatically.

Scenario template used: **ONE OF (EVENT) TO DO (ACTION)**.

Note: Motion detection and alarm / PIR detection are two essential elements to trigger Push Video.

10) INTERNAL ALARM (PIR) DETECTION ON WHEN GUARD ON

All channels are selected in this rule. When **Guard** is enabled from EagleEyes, our mobile app, the PIR detection of all channels is also enabled automatically.

Scenario template used: **ONE OF (EVENT) TO DO (ACTION)**.

Note: The alarms here refer to the alarm devices connected to the cameras or the recorder. For the alarm events triggered by the PIR sensor built into the camera, please choose PIR instead.

11) MOTION DETECTION OFF WHEN GUARD OFF

All channels are selected in this rule. When **Guard** is disabled from EagleEyes, our mobile app, the motion detection of all channels is also disabled automatically.

Scenario template used: **ONE OF (EVENT) TO DO (ACTION)**.

12) INTERNAL ALARM (PIR) DETECTION OFF WHEN GUARD OFF

All channels are selected in this rule. When **Guard** is disabled from EagleEyes, our mobile app, the motion detection of all channels is also disabled automatically.

Scenario template used: **ONE OF (EVENT) TO DO (ACTION)**.

13) PLAYBACK ON EVENT MONITOR (MOTION & EXTERNAL ALARM EVENT)

All channels are selected in this rule. When any motion or alarm event occurs, you'll see video playback on the monitor you set for **HDMI2 DISPLAY**.

Scenario template used: **ONE OF (EVENT) TO DO (ACTION)**.

Note: You'll also need to manually choose **EVENT MONITOR** and configure related settings in **DISPLAY → HDMI2 DISPLAY**. For details, please refer to "6.10 DISPLAY" at page 50.

6.3.2 Scenario Customization

Click and choose a template where you can press the button of **EVENT**, **RECORD**, **TIME** or **ACTION** to customize all your events and further actions:

1. ONE OF (**EVENT**) TO (**RECORD**)
2. ONE OF (**EVENT**) AT (**TIME**) TO DO (**ACTION**) AND THEN (**ACTION**)

3. AT (**TIME**) TO DO (ACTION) AND THEN (**ACTION**)
4. ALL OF (**EVENTS**) TO DO (**ACTION**) AND THEN (**ACTION**)
5. (**EVENTS**) TO TRIGGER (**RECORD**)
6. START (**RECORD**) AT (**TIME**)
7. ONE OF (**HEALTH EVENT**) OCCURRED AT (**TIME**) TO SEND PUSH STATUS
8. ONE OF (**EVENT**) TO DO (**ACTION**) AND THEN (**ACTION**)
9. ONE OF (**EVENT**) TO DO (**ACTION**)

EVENT

Up to 5 events could be added to the event list when you click the **EVENT** button.

Option		Description
MOTION and ALARM	MOTION	Choose at least one channel which has enabled motion detection.
	ALARM	Choose at least one channel which has connected to our brand's camera and an alarm sensor is connected to the camera.
	PIR	Choose at least one channel which has connected our brand's camera with a PIR sensor built-in.
IVS	FLOW COUNTING IN	Choose at least one channel which has enabled flow counting / one way / virtual fence / scene change depending on the option you've chosen.
	FLOW COUNTING OUT	
	ONE WAY PASS	
	VIRTUAL FENCE	
	CAMERA SCENE CHANGE	
HEALTH CHECK	LOGIN LOCKED	Choose at least one status that you want to pay attention to.
	SYSTEM ERROR	
	VIDEO LOST	
	VIDEO PLUGIN	
	NET LOGIN	
	POWER ON	
	UPS POWER LOST	
	UPS POWER RECOVERED	
	WAN UNPLUGGED	
	WAN PLUGIN	
	INTERNET CONNECTED	
	LAN PLUGGED	
	LAN PLUGIN	
	HDD CLEAN	
	HDD OVER TEMPERATURE	
	NO HDD EXIST	
	KEY UNLOCKED	
	FAN BROKEN	
FAN REPAIRED		
GUARD	GUARD	Enable or disable Push Video.

RECORD

Option		Description
START RECORDING EVENT CHANNEL	GROUP	Choose the record profile group you want defined in MENU → RECORD → RECORD STREAM when event recording is on.

TIME

Option		Description
EVERYDAY		Choose the pre-defined time range within which you want to activate the scenario rule.
HOLIDAY		
WEEKDAY		
<input type="checkbox"/>		Click <input type="checkbox"/> to customize the time range within which you want to activate the scenario rule.

ACTION







Up to 5 actions could be added to the action list when you click the **ACTION** button to combine a series of actions you'd like to have.

Option		Description
RECORDER	RECORD	Choose at least one channel to start recording, and the record profile to use when recording is on.
	RESTORE RECORD PROFILE	Restore the record profile group when the specified action is off.
	SET RECORD PROFILE	Choose the record profile group defined in MENU → RECORD → RECORD STREAM .
	START RECORDING EVENT CHANNEL	Choose the record profile group defined in MENU → RECORD → RECORD STREAM which is used for event-channel recording.
	STOP RECORDING EVENT CHANNEL	
	START RECORDING ALL CHANNELS	Choose the record profile group defined in MENU → RECORD → RECORD STREAM which is used for all-channel recording.
	STOP RECORDING ALL CHANNELS	
NOTIFICATION	PUSH VIDEO TO SEE PLAYBACK	When Push Video is received on the mobile device, slide to see event playback.
	PUSH VIDEO TO SEE LIVE	When Push Video is received on the mobile device, slide to see live images.
	PUSH MESSAGE	Enter the message you want to see on your mobile device when an event occurs.
	PUSH STATUS	Send Push Status to your mobile device.
	POP UP EVENT ON LIVE MONITOR	Choose at least one channel to show event icons, notifications and playback preview on the right pane of the live display.
	PLAYBACK VIDEO ON EVENT MONITOR	Choose at least one channel to show its event recording when an event occurs on the event monitor you configured in MENU → DISPLAY .
	VIDEO MAIL	You can choose to receive notifications by Email in four ways: 1. Event videos 2. Snapshots 3. Abnormal status 4. Text Make sure at least a recipient is selected in RECEIVER and configure the related settings in each setting page.
	EMAIL SNAPSHOT	
	EMAIL STATUS	
	EMAIL TEXT	
UPLOAD VIDEO TO FTP	You can choose to upload event videos or snapshots to the FTP site pre-defined in MENU → NETWORK → FTP . Make sure at least an FTP site is selected in PROFILE , and configure the related settings in each setting page.	
UPLOAD SNAPSHOT TO FTP		

Option		Description
CAMERA	PRESET	Choose the channel with a speed dome camera connected, and choose a preset point you want the camera to move to. To know how to set a preset point, please refer to "5.3 PTZ Control" at page 18.
	AUTO TRACKING	Choose the channel with a speed dome camera connected, and the camera supports auto tracking.
	CAMERA GUARD	Choose the channel with our brand's speed dome camera or motorized-pan camera connected, and enable this function to move the camera view to the preset point you specified. To know how to use this function, please refer to "ADVANCED CONFIG" in "6.1.4 DETECTION" at page 23.
	ENABLE MOTION	Choose at least one channel you want to enable motion detection.
	ENABLE PIR	Choose the channel with our brand's PIR camera connected.
I/O	RECORDER ALARM OUT	Choose to automatically activate the alarm-out device connected to the recorder.
	CAMERA ALARM OUT	Choose the channel with our brand's camera connected, and an alarm-out device (such as a buzzer) is connected to the camera. This option will automatically activate the alarm-out device connected to the camera.
	BUZZER	Choose to activate the buzzer built in the recorder to alert you.
MISC	DELAY	Set a timeout between each action.

6.4 IVS (For selected models only)

Before using this function, please check the specifications of your recorder and see if it supports this function and how many channels are supported. If your recorder supports 4 channels to use IVS, please connect this camera to any channel from CH1 to CH4.

IVS						
	IVS MODE		DISPLAY LINE	SCENE CHANGE	SCENE CHANGE LEVEL	SENSITIVITY
CH1	FLOW COUNTING	▼	OFF	OFF	MIDDLE	▼   
CH2	OFF	▼				
CH3	ONEWAY	▼	OFF	OFF	MIDDLE	▼   
CH4	OFF	▼				

1) IVS MODE



Select one of the following three modes depending on your environment:

MODE	DESCRIPTION
FLOW COUNTING	A virtual detection line is set to detect the moving direction of pedestrians for flow counting.
VIRTUAL FENCE	A virtual detection line is set to detect intruders crossing the detection line, and an alarm will be triggered.
ONE WAY	A virtual detection line is set to detect intruders from the specified direction, and an alarm will be triggered.

2) DISPLAY LINE

Select to display the detection line for IVS on the screen or not.

3) SCENE CHANGE

Select **ON** to trigger a motion event when the camera is sensed to be moved and the camera scene is changed. At the same time, the icon  will be also shown on the screen in addition to the motion icon .



4) SCENE CHANGE SENSITIVITY

Set the detection sensitivity for **SCENE CHANGE** to **HIGH, MIDDLE** or **LOW**.

5) SENSITIVITY

Set the sensitivity for IVS from **0 ~ 15**. The larger the value, the more sensitive the IVS will be.

6) (Clear) & (Edit)

Select  to clear the flow counting number, and  to enter the setting page to set the detection line. For details, please refer to the next section, "IVS Application".

IVS APPLICATION

➤ **FLOW COUNTING**

Step1: Click  to enter the setting page and draw a detection line with your mouse, and decide the detection direction by selecting **REVERSE**.



Step2: Click **APPLY** to finish the IVS setting and return to the live view.

When anyone walks across the detection line, the system will determine his movement is in or out, and add one count to the corresponding channel on the flow counting panel.

IN	People coming from the opposite direction to the arrow mark.
OUT	People coming from the same direction as the arrow mark.





➤ **VIRTUAL FENCE and ONE WAY**

Step1: Click  to enter the setting page and draw a detection line with your mouse, and decide the detection direction by selecting **REVERSE**.



Step2: Click **APPLY** to finish the IVS setting and return to the live view.

When anyone walks across the detection line, the system will determine his movement is in or out, and:

VIRTUAL FENCE	An event happens for anyone walking across the detection line, and “  ” will be shown on the screen.
ONE WAY	An event happens for anyone walking from the opposite direction to the arrow mark, and “  ” will be shown on the screen.





6.5 EXPORT

6.5.1 BACKUP

Note: Before using your USB flash drive for video backup, please format it to "FAT32" first with your PC or laptop. For the list of compatible USB flash drives, please refer to "APPENDIX 3 COMPATIBLE USB FLASH DRIVE LIST at page 72.

Note: Video backup could be made via a USB flash drive or the Internet. It's **NOT** allowed to connect the hard disk to your PC / laptop directly for it may impair the recorded data saved in the hard disk.

To copy recorded data for video backup, click  to add an item for backup. You can add several items to copy different data you need.

BACKUP					
 					
<input type="checkbox"/> SELECT	TIME	CHANNEL	BACKUP TYPE	DEVICE	STATUS
<input type="checkbox"/>	2017/07/18 23:03:52 ~ 2017/07/18 23:03:52	CH1	VIDEO	USB DEVICE	25%

BACKUP

SOURCE

DATA TYPE VIDEO LOG

















RANGE 2017/07/18 23:03:52 ~ 2017/07/18 23:03:52

< 2017 >	SUN	MON	TUE	WED	THU	FRI	SAT
	2	3	4	5	6	7	8
	9	10	11	12	13	14	15
	16	17	18	19	20	21	22
< JUL >	23	24	25	26	27	28	29
	30	31					

< 23:03:52 > HR MIN SEC

HOURS

CHANNEL ALL

CH1	CH2	CH3	CH4
 <input checked="" type="checkbox"/>	 <input type="checkbox"/>	 <input checked="" type="checkbox"/>	 <input type="checkbox"/>
CH5	CH6	CH7	CH8
 <input type="checkbox"/>	 <input type="checkbox"/>	 <input type="checkbox"/>	 <input type="checkbox"/>
CH9	CH10	CH11	CH12
 <input type="checkbox"/>	 <input type="checkbox"/>	 <input type="checkbox"/>	 <input type="checkbox"/>
CH13	CH14	CH15	CH16
 <input type="checkbox"/>	 <input type="checkbox"/>	 <input type="checkbox"/>	 <input type="checkbox"/>

DESTINATION

TARGET USB DEVICE

AVAILABLE SIZE 3 GB

STORAGE

USB PATH /VIDEO ...

TIME	CHANNEL	BACKUP TYPE	DEVICE	STATUS

CANCEL
BACKUP

Step1: In **SOURCE**, choose the data type (**VIDEO** or **LOG**) and the time range you want to copy from the calendar. The date with video recording will be shown in blue.

Step2: In **CHANNEL**, choose the channel(s) you want.

Step3: In **DESTINATION**, choose where you want to save the data, in a USB flash drive (**USB DEVICE**) or on FTP (**FTP**).

Step4: (Optional) If **USB DEVICE** is chosen, specify the directory in **STORAGE** if needed.

Step5: Choose **BACKUP** to start. The backup video will be in the AVI format.

Note: When the video compression format is H.265, please use the video player which supports H.265 to play the video footage.

6.5.2 SCHEDULE

This function is used to schedule video backup regularly, uploading security footages to a FTP site (remotely) or saving to an USB device connected to this device (locally).

You can configure up to 7 schedules and use one of them as your backup preference.

BACKUP

<p>SOURCE</p> <p>PROFILE: SCHEDULE1 <input type="button" value="v"/></p> <p>ACTIVE: ON</p> <p>RESOLUTION: RECORD STREAM <input type="button" value="v"/></p> <p>EXECUTION PERIOD: DAILY <input type="button" value="v"/></p> <p>EXECUTION TIME: MON 01</p> <p>RANGE: MON 08 : 00 ~ FRI 19 : 00</p>	<p>DESTINATION</p> <p>TARGET: FTP <input type="button" value="v"/></p> <p>STORAGE</p> <p>FTP PROFILE: Profile1 <input type="button" value="v"/></p> <p>FTP PATH: /VIDEO</p>
---	---

<p>CHANNEL <input type="checkbox"/> ALL</p> <table border="1" style="width: 100%; border-collapse: collapse; text-align: center;"> <tr> <td>CH1 <input checked="" type="checkbox"/></td> <td>CH2 <input type="checkbox"/></td> <td>CH3 <input checked="" type="checkbox"/></td> <td>CH4 <input type="checkbox"/></td> </tr> <tr> <td>CH5 <input type="checkbox"/></td> <td>CH6 <input type="checkbox"/></td> <td>CH7 <input type="checkbox"/></td> <td>CH8 <input type="checkbox"/></td> </tr> <tr> <td>CH9 <input type="checkbox"/></td> <td>CH10 <input type="checkbox"/></td> <td>CH11 <input type="checkbox"/></td> <td>CH12 <input type="checkbox"/></td> </tr> <tr> <td>CH13 <input type="checkbox"/></td> <td>CH14 <input type="checkbox"/></td> <td>CH15 <input type="checkbox"/></td> <td>CH16 <input type="checkbox"/></td> </tr> </table>	CH1 <input checked="" type="checkbox"/>	CH2 <input type="checkbox"/>	CH3 <input checked="" type="checkbox"/>	CH4 <input type="checkbox"/>	CH5 <input type="checkbox"/>	CH6 <input type="checkbox"/>	CH7 <input type="checkbox"/>	CH8 <input type="checkbox"/>	CH9 <input type="checkbox"/>	CH10 <input type="checkbox"/>	CH11 <input type="checkbox"/>	CH12 <input type="checkbox"/>	CH13 <input type="checkbox"/>	CH14 <input type="checkbox"/>	CH15 <input type="checkbox"/>	CH16 <input type="checkbox"/>	→
CH1 <input checked="" type="checkbox"/>	CH2 <input type="checkbox"/>	CH3 <input checked="" type="checkbox"/>	CH4 <input type="checkbox"/>														
CH5 <input type="checkbox"/>	CH6 <input type="checkbox"/>	CH7 <input type="checkbox"/>	CH8 <input type="checkbox"/>														
CH9 <input type="checkbox"/>	CH10 <input type="checkbox"/>	CH11 <input type="checkbox"/>	CH12 <input type="checkbox"/>														
CH13 <input type="checkbox"/>	CH14 <input type="checkbox"/>	CH15 <input type="checkbox"/>	CH16 <input type="checkbox"/>														

Step1: In **SOURCE**, choose the profile you'd like to save all the settings configured in **SOURCE**.

Choose the video resolution (**SUBSTREAM / RECORD STREAM**), how often and when you'd like the backup to execute (**EXECUTION PERIOD / EXECUTION TIME**), and the time which includes the recordings you want (**RANGE**).

Step2: In **CHANNEL**, choose the channel(s) you want.

Step3: In **DESTINATION**, choose where you want to save the data, in a USB flash drive (**USB DEVICE**) or on FTP (**FTP**).

Step4: (Optional) If **FTP** is chosen in **DESTINATION**, go to **STORAGE**, and choose the profile you'd like to save the storage path configured in **FTP PATH**.

Then, specify the directory where you'd like the recordings to be uploaded in **FTP PATH**.

Step5: Click **APPLY** to confirm.

6.5.3 REGULAR REPORT

This function is used to send event reports to the specified E-mail address. Users could configure up to 5 profiles to receive different reports about specific channels at different time.

Note: This function is available only when a hard disk is installed, and the recorder is connected to Internet.

You can configure up to 7 profiles and use one of them as your backup preference.

BACKUP

<p>SOURCE</p> <p>PROFILE: PROFILE1 <input type="button" value="v"/></p> <p>ACTIVE: ON</p> <p>EXECUTION PERIOD: WEEKLY <input type="button" value="v"/></p> <p>EXECUTION DAY OF WEEK: MON <input type="button" value="v"/></p> <p>EXECUTION HOUR: 1 <input type="button" value="v"/></p>	<p>DESTINATION</p> <p>EVENT TYPE: 4 SELECTED <input type="button" value="v"/></p> <table border="1" style="width: 100%; border-collapse: collapse;"> <tr> <th style="width: 15%;">EDIT</th> <th>E-MAIL ADDRESS</th> </tr> <tr> <td style="text-align: center;"> <input type="button" value="✎"/> <input type="button" value="✖"/> <input type="button" value="⊕"/> <input type="button" value="📧"/> </td> <td style="text-align: center;">tech_support@gmail.com</td> </tr> </table>	EDIT	E-MAIL ADDRESS	<input type="button" value="✎"/> <input type="button" value="✖"/> <input type="button" value="⊕"/> <input type="button" value="📧"/>	tech_support@gmail.com
EDIT	E-MAIL ADDRESS				
<input type="button" value="✎"/> <input type="button" value="✖"/> <input type="button" value="⊕"/> <input type="button" value="📧"/>	tech_support@gmail.com				

<p>CHANNEL <input checked="" type="checkbox"/> ALL</p> <table border="1" style="width: 100%; border-collapse: collapse; text-align: center;"> <tr> <td>CH1 <input checked="" type="checkbox"/></td> <td>CH2 <input type="checkbox"/></td> <td>CH3 <input checked="" type="checkbox"/></td> <td>CH4 <input type="checkbox"/></td> </tr> <tr> <td>CH5 <input type="checkbox"/></td> <td>CH6 <input type="checkbox"/></td> <td>CH7 <input type="checkbox"/></td> <td>CH8 <input type="checkbox"/></td> </tr> <tr> <td>CH9 <input type="checkbox"/></td> <td>CH10 <input type="checkbox"/></td> <td>CH11 <input type="checkbox"/></td> <td>CH12 <input type="checkbox"/></td> </tr> <tr> <td>CH13 <input type="checkbox"/></td> <td>CH14 <input type="checkbox"/></td> <td>CH15 <input type="checkbox"/></td> <td>CH16 <input type="checkbox"/></td> </tr> </table>	CH1 <input checked="" type="checkbox"/>	CH2 <input type="checkbox"/>	CH3 <input checked="" type="checkbox"/>	CH4 <input type="checkbox"/>	CH5 <input type="checkbox"/>	CH6 <input type="checkbox"/>	CH7 <input type="checkbox"/>	CH8 <input type="checkbox"/>	CH9 <input type="checkbox"/>	CH10 <input type="checkbox"/>	CH11 <input type="checkbox"/>	CH12 <input type="checkbox"/>	CH13 <input type="checkbox"/>	CH14 <input type="checkbox"/>	CH15 <input type="checkbox"/>	CH16 <input type="checkbox"/>	→
CH1 <input checked="" type="checkbox"/>	CH2 <input type="checkbox"/>	CH3 <input checked="" type="checkbox"/>	CH4 <input type="checkbox"/>														
CH5 <input type="checkbox"/>	CH6 <input type="checkbox"/>	CH7 <input type="checkbox"/>	CH8 <input type="checkbox"/>														
CH9 <input type="checkbox"/>	CH10 <input type="checkbox"/>	CH11 <input type="checkbox"/>	CH12 <input type="checkbox"/>														
CH13 <input type="checkbox"/>	CH14 <input type="checkbox"/>	CH15 <input type="checkbox"/>	CH16 <input type="checkbox"/>														

Step1: In **SOURCE**, choose the profile you'd like to save all the settings configured in **SOURCE**. Choose how often and when you'd like to receive reports. Finally, make sure this profile is active (**ACTIVE** to **ON**).

EXECUTION PERIOD	Select how often you want to receive reports: MONTHLY , WEEKLY or DAILY .
EXECUTION DAY OF MONTH / EXECUTION DAY OF WEEK	Depending on the option you selected in EXECUTION PERIOD : <ul style="list-style-type: none"> ■ EXECUTION DAY OF MONTH shows when MONTHLY is selected. Select one date from 1 ~ 31. ■ EXECUTION DAY OF WEEK shows when WEEKLY is selected. Select one day from Monday ~ Sunday.

Step2: In **CHANNEL**, choose the channel(s) you want.



Step3: In **DESTINATION**, choose which event type(s) you want to see (**MANUAL / MOTION / ALARM / SYSTEM / TIMER / HUMAN DETECTION**).

Step4: Click to manually add an Email address to receive reports or to select from the E-mail address list pre-defined in **NETWORK → E-MAIL**, to modify the selected Email address, and to remove the selected Email address from the recipients list.

Step5: Click **APPLY** to confirm.

6.6 STORAGE

In this menu, you can check the status of each connected hard disk and configure some precaution actions to protect each hard disk and the video data saved in it such as reminding of hard disk erasing or avoiding the hard disks being over-heated.

STORAGE									
HDD NEARLY FULL (GB)							5	▼	
HDD OVERHEAT ALERT (°C)							70	▼	
OVERWRITE							ON		
KEEP DATA LIMIT(DAYS)							OFF	▼	
TEMPERATURE TO ENABLE FAN (°C)							30	▼	
REMINDER WHEN FORMATTING HDD							OFF		
	ID	TYPE	STATUS	SIZE	TEMP.	SERIAL NUMBER	FREE SIZE	FORMAT TIME	HEALTH STATUS
  	HDD5	NORMAL	READY	750GB	33°C	WD-WCAV53797317	269.856GB	2017/07/18 23:03:52	GOOD

1) HDD NEARLY FULL (GB)

If **HDD BUZZER** is enabled in **MAINTAIN**, select the duration time for buzzer notifications when the hard disk available capacity is 5/10/15/20 GB left.

2) HDD OVERHEAT ALERT (°C)

Select the temperature alert for your hard disk to be aware of the possible overheat of your hard disk.

3) OVERWRITE

By default, the HDD overwritten function is set to ON, and  will be shown on the screen.

4) KEEP DATA LIMITS (DAYS)

Assign how many days to save the recording data from **1** to **31** days. After the assigned day(s), the recorded data will be removed. Select **OFF** to disable this function.

5) TEMPERATURE TO ENABLE FAN (°C)

Choose the temperature (**25 / 30 / 35 / 40**) to enable the built-in fan to work for heat dissipation.

6) REMINDER WHEN FORMATTING HDD

Enable this function to allow the recorder to prompt first when it needs to format your hard disk; otherwise the recorder will format the hard disk without asking.

7) HDD information

You can check the remaining capacity of the connected hard disk in this device and its current status.

If the health status goes to:

- **GOOD** - This hard disk works normal.
- **BELOW AVERAGE** - The hard disk might work with some errors. Please pay attention and do video backup if needed.
- **REPLACEMENT NEEDED** – Please replace this hard disk immediately to ensure continuous video recording.

8)  HDD details



You can check the details of the selected hard disk.

9)  HDD formation

Click to format the selected hard disk and erase all data. When a hard disk is inserted to the recorder for the first time, it's compulsory to format the hard disk for it to work properly.

10)  Mount /  Unmount HDD

HDD hot-swapping is supported for this device. There's no need to power off the device first to install or remove a hard disk.

When a hard disk is installed, you'll need to click  to manually mount the hard disk for it to work properly. When you need to remove a hard disk, click  to unmount the hard disk and you'll be able to remove it.



Note: It's not allowed to remove a hard disk directly.

6.7 ACCOUNT

Note: This function is available only for **SUPERVISOR**.

6.7.1 USER LIST

This function is used to create a new user account, or modify or delete an existing account for different access privilege.

USER LIST		
EDIT	USER NAME	GROUP
 	admin	SUPERVISOR
		

■ How to create an account

Select , enter a user name and its password, and assign a user group in which includes the access rights you wish to grant to this new account. Then, select **SAVE** to create and return to the user list page.



Note: Four user levels are pre-defined in the system for you to quickly choose: **SUPERVISOR, POWER USER, USER & GUEST**. For details about available operations of each level, please refer to "6.7 ACCOUNT" at page 46.





ADD			
USER NAME	TEST1		
PASSWORD	●●●●●●●●		
CONFIRM PASSWORD	●●●●●●●●		
GROUP	POWER USER 		
<table border="1" style="width: 100%;"> <tr> <td style="width: 50%; text-align: center;">SAVE</td> <td style="width: 50%; text-align: center;">CANCEL</td> </tr> </table>		SAVE	CANCEL
SAVE	CANCEL		

6.7.2 GROUP

This function is used to create a new group with customized user access rights for different functions if needed, and you can create a user account and assign it to your customized group.

Note: The default user groups are **SUPERVISOR, POWER USER, USER** and **GUEST**, and they're not allowed to be removed. For details about available local operations of each user group, please refer to "6.7 ACCOUNT" at page 46.

BACKUP				
MANAGER	▼			
GENERAL	LOCAL	NETWORK		
BACKUP			ALL	▼
PTZ CONTROL			OFF	
POWER CONTROL			ON	
REVIEW LOG			ON	
CONFIG SETUP			OFF	
CLEAR LOG			OFF	
ACCOUNT SETUP			OFF	
CLEAR HDD			OFF	
PUSH VIDEO			ON	
PUSH STATUS			ON	
ALARM OUT			ON	
				APPLY

Icon	Meaning	Description
	Delete	Choose a customized user group and delete it. The default user groups (SUPERVISOR, POWER USER, USER and GUEST) can't be removed.
	Add	Click to enter a group name, and select the tabs of GENERAL, LOCAL and NETWORK to choose the corresponding functions you want to enable or disable. Then, click APPLY to confirm.
	Import	You need to create a user group first to use this function. Choose one of the default user groups you want to modify for your customized group from the drop-down list and click  choose a customized group to import the configurations. Then, you can quickly modify the configurations and click APPLY to confirm.

6.8 NETWORK

- **WAN** is used to connect this recorder to Internet for remote access from anywhere as long as Internet access is available.
- **DDNS** is used when the Internet access is available.



Note: For more details about these three functions and network configurations, please get the setup manual from www.surveillance-download.com/user/network_setup/network_setup_recorder.pdf.

WAN	WAN	
DDNS	NETWORK TYPE	STATIC ▼
E-MAIL	IP	192.168.1.112
FTP	GATEWAY	192.168.1.254
EaZy	NETMASK	255.255.255.0
	PRIMARY DNS	168.95.1.1
	SECONDARY DNS	139.175.55.244
	PORT	88
	INTERNET AVAILABILITY ADDRESS	www.google.com
	MAC 00:0E:53:00:13:77	

6.8.1 E-MAIL

Configure your E-mail account here to send event notifications or reports.

Note: To know the SMTP server and port number you should use, please check with your E-mail service provider.

E-MAIL	
SMTP SERVER	SMTP.GMAIL.COM
PORT	465
MAIL FROM	OFFICE_MANAGER@GMAIL.COM
SSL ENCRYPTION	ON
VERIFY PASSWORD	ON
USER NAME	MANAGER
PASSWORD	●●●●●●
EDIT	E-MAIL ADDRESS
 	manager_1@fulltech.com
	

6.8.2 FTP

Configure up to 7 FTP sites here to upload event notifications or reports.

FTP							
FTP 1	FTP 2	FTP 3	FTP 4	FTP 5	FTP 6	FTP 7	
NAME							Profile1
SERVER							211.75.33.2144
PORT							25
USER NAME							office
PASSWORD							●●●●●●
							APPLY

6.8.3 EaZy

This function is used to connect this recorder to Internet by using EaZy Networking. For details, please refer to “APPENDIX 6 EAZY NETWORKING” at page 75.

EaZy	
ENABLE EAZY NETWORKING	ON
	
MAC: 000e53eca7b4 UUID: E736DCBF-D4BB-4CA8-86FD-62658E2ECEC1 PORT: 80 EAZY NETWORKING OFFLINE	

6.9 TIME

6.9.1 TIME SETUP

TIME SETUP	
DATE	2009 / NOV / 17
TIME	15 : 35 : 53
FORMAT	Y/M/D
NTP SERVER	Pool.ntp.org
SYNC PERIOD	DAILY
GMT	(UTC+08:00)TAIPEI
CLIENT TIME SYNC VIA RECORDER	OFF

- 1) DATE
Set the current date. The default display format is YEAR – MONTH – DATE (**Y-M-D**).
- 2) TIME
Set the current time in HOUR : MIN : SEC.
- 3) FORMAT
Set the time display format: **Y/M/D**, **M/D/Y** or **D/M/Y**.
- 4) NTP SERVER
Click to change the default NTP server to another server they're familiar with, or keep the default NTP server.
- 5) SYNC PERIOD
Select to synchronize the device time every day (**DAILY**), or turn this function off (**OFF**).
- 6) GMT
Select your time zone.
- 7) CLIENT TIME SYNC VIA NVR WAN (*Applicable when an IP camera is connected*)
Enable this function to synchronize the time of the connected IP cameras via the recorder when the recorder is connected to the Internet. This could ensure the time of the recorder and IP cameras are the same to prevent the confusion of time inconsistency.

Note: You may receive NTP-based DDoS attacks when this function is enabled. Please make sure your network is secured to prevent this kind of attack.

6.9.2 DAYLIGHT

DAYLIGHT							
DAYLIGHT SAVING					ON		
START TIME	1ST	▼	MON	▼	AUG	▼	06:00
END TIME	LAST	▼	MON	▼	OCT	▼	10:00
ADJUST					01:00		

Depending on the time zone you're in:

- 1) DAYLIGHT SAVING
Select to enable (**ON**) or disable (**OFF**) this function.
- 2) START TIME / END TIME
Set the start time and end time.
- 3) ADJUST
Set the time in HOUR : MIN.

6.10 DISPLAY

DISPLAY		
CHANNEL TITLE	ON	
EVENT STATUS	ON	
AUTO KEY LOCK(S)	30	
HDD DISPLAY MODE	RE,MAINING SIZE	▼
DISPLAY OUTPUT	AUTO	▼
LANGUAGE	ENGLISH	▼
SPOT MONITOR	SETUP	
CALL SCREEN DURATION	03	
QUAD SCREEN DURATION	03	

- 1) CHANNEL TITLE
Select to display the channel title or not (**ON / OFF**).
- 2) EVENT STATUS
Select to display the event icons or not (**ON / OFF**).

Note: For details about each event icon, please refer to "4.3 Status & Operation" at page 12.

- 3) AUTO KEY LOCK(S)
Set the time-out in second after which the key lock function is activated (**NEVER / 30 / 60 / 120**).
- 4) HDD DISPLAY MODE
Select **REMAINING SIZE** to show the remaining HDD capacity for recording in GB, or **REMAINING TIME** to show the remaining recording time.
- 5) DISPLAY OUTPUT
Select the display resolution you want. The default value is **AUTO**. This is used for the main display output.

Note: To have the best image quality on your monitor, make sure (1) the selected output resolution is supported by your monitor, and (2) the output settings on both the LCD monitor and the recorder are consistent.

If the image is not positioned or scaled properly, please go to your monitor's menu for adjustment. For details, please refer to the user manual of your monitor.

6) LANGUAGE

Select the language of the OSD.

7) SPOT MONITOR

Specify how VGA / composite port is used for video output: **CALL MONITOR / EVENT MONITOR / LIVE.**

Note: For some models, only the VGA or composite port supports this function. The available output options depend on the model you have.

- **CALL MONITOR** is used for sequence display. When this option is selected, go to **CALL SCREEN DURATION** to select the duration time in second (**03 / 05 / 10 / 15**) and **CALL MONITOR PERMIT** to choose the channel(s) you want for sequence display.

SPOT MONITOR		
SPOT MONITOR	VGA	▼
VGA RESOLUTION	1920 x 1080	▼
SPOT DISPLAY	CALL MONITOR	▼
CALL SCREEN DURATION	5	▼
CALL MONITOR PERMIT	4 selected	▼

- **EVENT MONITOR** is used when **any** alarm event occurs. When this option is selected, go to **LAYOUT** to select how many channels you want to see, and **PRE-ALARM (SEC)** and **POST-ALARM (SEC)** to set how many seconds you'd like to see before (**0 ~ 5**) and after (**3 ~ 10**) the event starts.

SPOT MONITOR		
SPOT MONITOR	VGA	▼
VGA RESOLUTION	1920 x 1080	▼
SPOT DISPLAY	EVENT MONITOR	▼
LAYOUT	4	▼
PRE-ALARM (SEC)	3	▼
POST-ALARM (SEC)	5	▼

- **LIVE** is used to select how many channels you'd like to show on the spot monitor. You can configure up to 7 profiles for live display.

SPOT MONITOR		
SPOT MONITOR	VGA	▼
VGA RESOLUTION	1920 x 1080	▼
SPOT DISPLAY	LIVE	▼
PROFILE	1	▼
LAYOUT	4	▼

CH1

▼

CH3

▼

CH5

▼

CH8

▼

8) CALL SCREEN DURATION

Select the duration time in second (**03 / 05 / 10 / 15**) when the channel display mode is 1-cut and (Sequence) is selected.



9) QUAD SCREEN DURATION

Select the duration time in second (**03 / 05 / 10 / 15**) when the channel display mode is 4-cut and (Sequence) is selected.



6.11 PERIPHERAL

6.11.1 LOCAL

LOCAL	
MOUSE SENSITIVITY	
REMOTE CONTROL ID	0

1) MOUSE SENSITIVITY

Select the mouse sensitivity. The higher the value, the more sensitive the mouse.

1) REMOTE CONTROL ID

This function is available when users need to control two or more recorders with one IR remote controller. The ID set here is used to identify the recorder the remote controller is going to control. Please also read the user manual of the IR remote controller for details.

6.11.2 JOYSTICK

In this menu, you can adjust the speed of pan / tilt movement of the speed dome camera or a motorized-pan camera.

Note: To control the movement of the speed dome camera, you can choose  from the PTZ control panel and move on the screen ("5.3 PTZ Control" at page 18), or simply connect the compatible joystick, AVX102, to the DVR.

JOYSTICK	
MAX SPEED OF X AXIS	
MAX SPEED OF Y AXIS	
CURVE ORDER OF X AXIS	1
CURVE ORDER OF Y AXIS	1

6.11.3 LOCAL ALARM IN

Note: This function is used when the recorder supports alarm-in connection and there's an alarm sensor such as an infrared sensor connected to the recorder. For configuring the alarm sensor connected directly to the camera, please refer to "6.1.4 DETECTION" at page 23.

Choose how the alarm sensor you connected works: **OFF / N.C. / N.O.**

The alarm device connected to Alarm IN 1 will work with video channel 1, the alarm device connected to Alarm IN 2 will work with video channel 2 and so on.

LOCAL ALARM IN		
CHANNEL TITLE	ALARM IN	
CH1	OFF	▼
CH2	N.C.	▼
CH3	N.O.	▼
CH4	OFF	▼
		APPLY

6.11.4 LOCAL ALARM OUT

Note: This function is used when the recorder supports alarm-out connection and there's an alarm-out device such as a buzzer connected to the recorder. For configuring the alarm-out device connected directly to the camera, please refer to "6.1.5 ALARM OUT" at page 26.

LOCAL ALARM OUT		
NAME	RESTORE AUTOMATICALLY	ALARM OUT DURATION (SECS)
Alarm Out	ENABLE ▼	1 ▼
		APPLY

1) RESTORE AUTOMATICALLY

When this function is enabled, the alarm-out device will return to the state before it's triggered automatically after the time configured in **ALARM OUT DURATION (SECS)**.

2) ALARM OUT DURATION (SECS)

Choose how long the alarm-out device will be activated when it's triggered: **1 / 3 / 5 / 10 / 20 / 30 / 60 / 120 / 180**.

6.11.5 DEVICES

Note: This function is used when the recorder supports RS485 connection and you want to connect other brand's speed dome camera.

DEVICES									
CHANNEL TITLE	DEVICE		ID	PROTOCOL		RATE		INTERFACE	
CH1	PTZ	▼	1	P-P	▼	2400	▼	RS-485	▼
CH2	CAMERA	▼	2	NORMAL	▼	4800	▼	COAXIAL	▼
CH3	CAMERA	▼	0	NORMAL	▼	2400	▼	COAXIAL	▼
CH4	CAMERA	▼	0	NORMAL	▼	2400	▼	COAXIAL	▼

1) DEVICE

For connecting other brand's speed dome camera, select **PTZ**.

2) ID

Click the current value to set the ID number (0 ~ 255) for the connected camera if necessary.

Make sure the ID setting of the camera is the same as the setting here, or the recorder will not be able to control the device.

Note: To know the default ID of the speed dome camera, please refer to its user manual.

3) PROTOCOL

Select **NORMAL** (our protocol), **P-D** (PELCO-D), **P-P** (PELCO-P), **S-T** (SAMSUNG-T) or **S-E** (SAMSUNG-E) protocol.

4) DEVICE

Select the baud rate for the connected speed dome camera (**2400 / 4800 / 9600 / 19200 / 38400 / 57600 / 115200**).

Make sure the baud rate setting of the camera is the same as the setting here, or the recorder will not be able to control the device.

Note: To know the default baud rate of the speed dome camera, please refer to its user manual.

5) INTERFACE

Select **RS485** if the connected speed dome camera uses RS485 wires to transmit control signals.

6.12 MAINTAIN

6.12.1 SYSTEM

SYSTEM	
BACKUP CONFIG	SUBMIT
RESTORE CONFIG	SUBMIT
RESET DEFAULT	SUBMIT
DEVICE TITLE	dvr_1
ENABLE AUTO PLUG AND PLAY	ON
BIND MAC ADDRESS	OFF

1) BACKUP CONFIG / RESTORE CONFIG

To save the DVR current configurations for later use, such as restoring after DVR upgrade or applying to another DVR, insert a compatible USB flash drive into the USB port, and select SUBMIT in **SUBMIT** in **BACKUP CONFIG** to copy the current DVR configurations to a file "System.bin" and save to your USB flash drive.

To restore the DVR configurations, insert the USB flash drive including "System.bin" to the USB port, and select **SUBMIT** in **RESTORE CONFIG**.

2) RESET DEFAULT

Click **SUBMIT** to reset all settings or partial settings to their factory default values, and select **YES** to confirm or **NO** to cancel. The system will reboot after reset.

3) DEVICE TITLE

Enter a title for this device.

4) ENABLE AUTO PLUG AND PLAY

Switch to **ON** to allow the camera to be detected and configured automatically when it's connected to this device.

Note: This function is available only when the brand of the cameras connected is the same as this device.

5) BIND MAC ADDRESS

This function is recommended to be used when your surveillance system is more than 256 cameras. It would be helpful for the system to get the address of each connected camera quickly if the system accidentally shuts down and needs to recover.

6.12.2 UPGRADE

In this menu, you can choose to upgrade your recorder (**LOCAL**) or the connected our brand's IP cameras (**CAMERA**).

LOCAL

Save the upgrade files obtained from your installer or distributor in a compatible USB flash drive, and insert it into the USB port. Then, click **SUBMIT** to start upgrading.

Note: Before using the USB flash drive, please use your PC to format the USB flash drive to FAT32 format first. For the list of compatible USB flash drives, please refer to "APPENDIX 3 COMPATIBLE USB FLASH DRIVE LIST at page 72.

UPGRADE	
LOCAL	CAMERA
UPGRADE	SUBMIT
VERSION	1002-1001-1001-1000



CAMERA

You can choose to upgrade several connected IP cameras from the recorder as long as the cameras are our brand's IP cameras.

UPGRADE				
LOCAL	CAMERA			
CHANNEL	VERSION	DIRECTORY	STATUS	
CH1	1085-1032-1046-1020-A1A1	/mnt/usb/FullImg-1086-1033-1046-1020.bin		+ 🗑️ 📄
CH2	1020S-1007S-1011S-1009S			+
CH3				+
CH4				+
			UPGRADE	COPY TO
				✓

Step1: Save the upgrade files obtained from your installer or distributor in a compatible USB flash drive, and insert it into the USB port.

Step2: Choose  to browse to where the firmware file is saved and choose the file to upgrade. Then, choose **SELECT** to confirm and return to the upgrade page.

	/	USB DEVICE	▼	
NAME	SIZE	TYPE	MODIFIED DATE	
Fullimg-1086-1033-1046-1020.bin	27.6MB	regular file	2017-07-13 12:19:32	
Fullimg-1022-1007-1011-1009.bin	9.6MB	regular file	2017-08-16 17:05:16	
		<input type="button" value="CANCEL"/>		<input type="button" value="SELECT"/>

Step3: Repeat Step2 as many as needed until all cameras which need firmware upgrade are selected.

If one firmware file applies to several IP cameras, select **COPY TO** to apply the same file to the applicable cameras.

Step4: Choose **UPGRADE** to start upgrading all selected cameras, or choose  to upgrade the camera one by one.

6.12.3 ALERT

ALERT	
EXT. ALERT	OFF
INT. BUZZER	ON
KEY BUZZER	ON
VLOSS BUZZER	ON
MOTION BUZZER	ON
ALARM BUZZER	ON
HDD BUZZER	ON
ALARM BUZZER DURATION (SEC)	10 ▼

1) EXT. ALERT

Select to enable or disable the sound when any external alarm is triggered (**ON / OFF**).

2) INT. BUZZER

Select to enable or disable the sound (**ON / OFF**) for all internal buzzers: **KEY BUZZER, VLOSS BUZZER, MOTION BUZZER, ALARM BUZZER, and HDD BUZZER.**

Note: When this item is set to **OFF**, item 3) to item 7) will be disabled even though they are set to **ON**.

3) KEY BUZZER

Select to enable or disable the sound when pressing the buttons on the front panel (**ON / OFF**).

4) VLOSS BUZZER

Select to enable or disable the sound when video loss happened (**ON / OFF**).

5) MOTION BUZZER

Select to enable or disable the sound when any motion alarm is triggered (**ON / OFF**).

6) ALARM BUZZER

Select to enable or disable the sound when any internal alarm is triggered (**ON / OFF**).

7) HDD BUZZER

Select to enable or disable the sound (**ON / OFF**) when the HDD remaining capacity reaches to the value set in **HDD NEARLY FULL (GB)**.

8) ALARM BUZZER DURATION (SEC)

Select the duration time for alarm buzzer in second (**5 / 10 / 20 / 40**).

6.12.4 EVENT LOG

You can check all the event information (event type, time and channel), or clear all log records.

EVENT LOG		
EVENT	TIME	COMMENT
KEY UNLOCK	2011/NOV/19 15:49:07	
VIDEO LOSS	2011/NOV/19 15:32:05	04
POWER ON	2011/NOV/19 15:32:02	
		PREV NEXT CLEAN

6.12.5 ONLINE

ONLINE		
ANONYMOUS VIEWER LOGIN	OFF	
DROP ALL CONNECTION	SUBMIT	
LOGIN FAILURE TIMES	3	▼
LOCK TIME FOR LOGIN FAILURES	10 MINS	▼

1) ANONYMOUS VIEWER LOGIN

Switch to **ON** to allow anonymous login, meaning there's no need to enter user name and password for remote access.

2) DROP ALL VIDEO CONNECTION

Click **SUBMIT** to force disconnection of all remote logins when needed.

3) LOGIN FAILURE TIMES

The recorder will lock the IP address with several login attempts. Choose the failure times of login attempts from the same IP address (**1 ~ 20**), and go to the next option, **LOCK TIME FOR LOGIN FAILURES**, to choose how much time you'd like to lock the IP address.

4) LOCK TIME FOR LOGIN FAILURES

Choose how much time you'd like to lock the IP address with several login attempts but failed (**1 MIN / 2 MINS / 3 MINS / 5 MINS / 10 MINS / 30 MINS / 1 HOUR**).

6.13 POWER CONTROL

Click to show the power off panel to halt, reboot or log out the system.

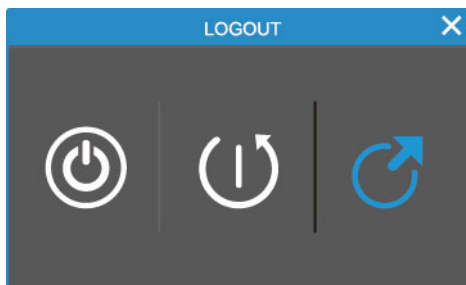

Icon	Meaning	Description
	System Halt	Click to stop the system and remove the power adapter.
	System Reboot	Click to reboot the system.
	System Logout	Click to log out the system and log in with another account.

6. REMOTE OPERATION

You can also control this recorder remotely via the web browser and iOS / Android devices.

6.2 Web Browser

You can view the images or operate your recorder with a web browser, for example, Windows Edge, Microsoft Internet Explorer, Google Chrome, Mozilla Firefox & Safari.

Note: The supported PC operation systems are Windows 10, Windows 8, Windows 7 and Windows Vista.

Note: When the video compression format of a channel is H.265, you might not be able to see the live feed remotely via the web browser since the browser may not support to display this format. Please change the compression format to H.264 if needed.

The user interface when you access via the web browser is nearly the same as the interface you see on the recorder, and the operations are also the same.

Note: The illustration below is just for your reference and may be different from what you actually see. Some functions and buttons are for selected models or certain user levels only.

Step 1: Key in the IP address used by this device in the URL address box, such as 60.121.46.236, and press Enter. You will be prompted to enter the user name and password to access the device.

If the port number this device used is NOT 80, you need to key in the port number additionally. The format is *ipaddress:portnum*.

For example, for the IP address 60.121.46.236 and port No. 888, please key in "http://60.121.46.236:888" into the URL address box, and press "Enter".

Step 2: Enter the user name and password, and click "OK". You will see a similar screen as the following when the login information is correct.

Note: The default user name and password for remote access are both "admin".

Current Streaming Information:
 FR: Frame rate
 DR: Data rate
 DATE TIME: Current system time

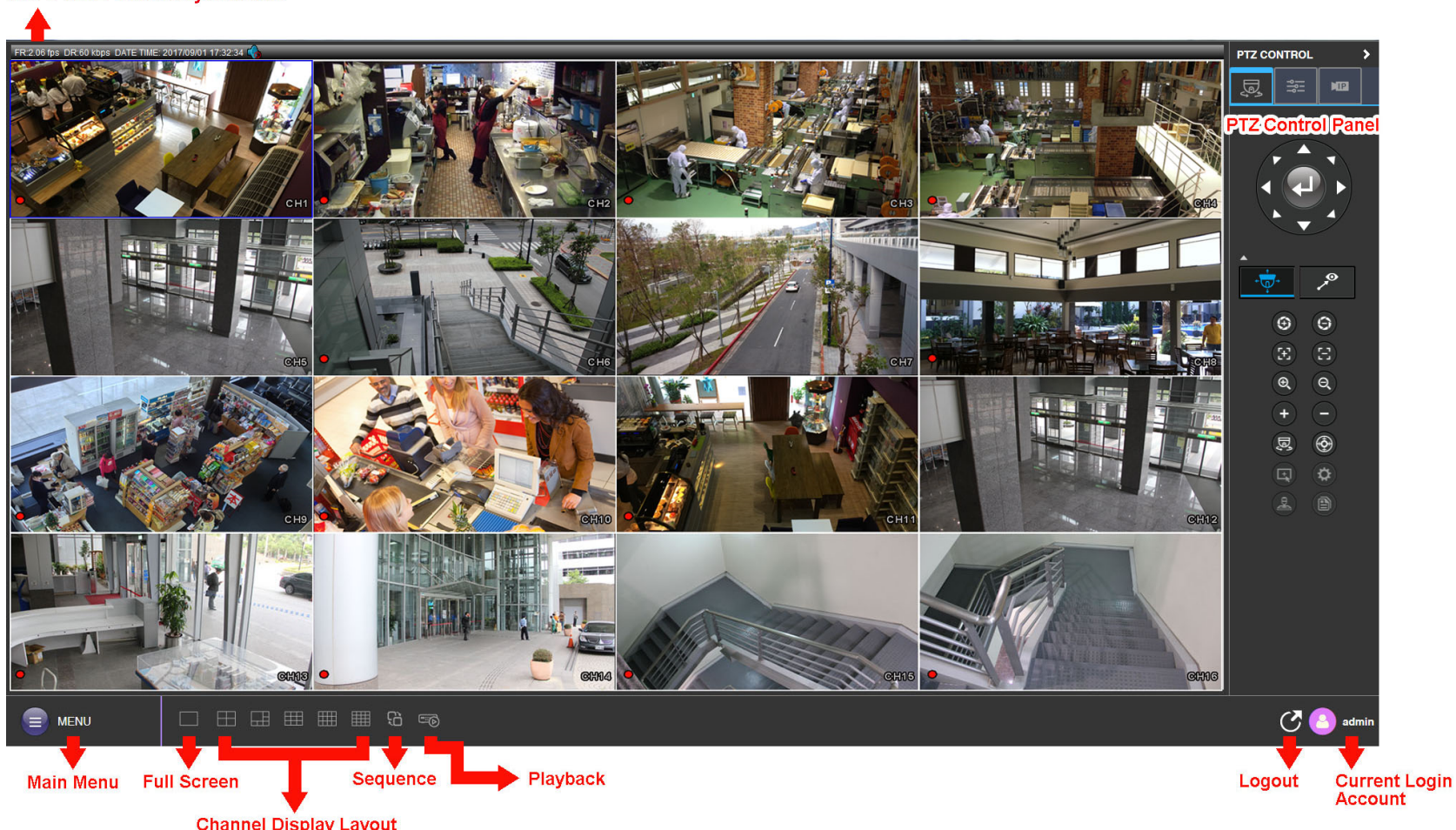

6.3 Mobile Devices

Note: For more details about mobile surveillance via your mobile device, please visit <http://info.eagleeyes.tw/iphone/index.html>.

EagleEyes is a mobile phone program used with our surveillance system for remote surveillance. It's compatible with iOS and Android mobile devices, and it's free (Except *EagleEyes Plus* for iOS OS, and *EagleEyes Plus+* for Android OS).

6.3.1 Prerequisites

Before installing *EagleEyes* to your mobile phone for remote surveillance, make sure you have checked the following:

- ✓ Your mobile platform is iOS or Android.
- ✓ Mobile Internet services are subscribed and available to use for your mobile device.

Note: You might be charged for Internet access via wireless or 4G networks. For the Internet access rate details, please check with your local network operator or service provider.

- ✓ You have noted down the IP address, port number, user name and password used to access your network camera from Internet.

6.3.2 Where to download

Go to **App Store / Play Store** from your iOS / Android mobile devices and search *EagleEyes* to download.

When the download is completed, *EagleEyes* will be installed automatically to the location where all applications are saved in your phone by default, or where you specify.

6.3.3 Manual Setup

Note: To know how to configure by EaZy Networking, please refer to "APPENDIX 6 EAZY NETWORKING" at page 75.

Step1: Open *EagleEyes* to go to the address book.

Step2: Then, click **Add** and select **Manual** to go to the setting page.

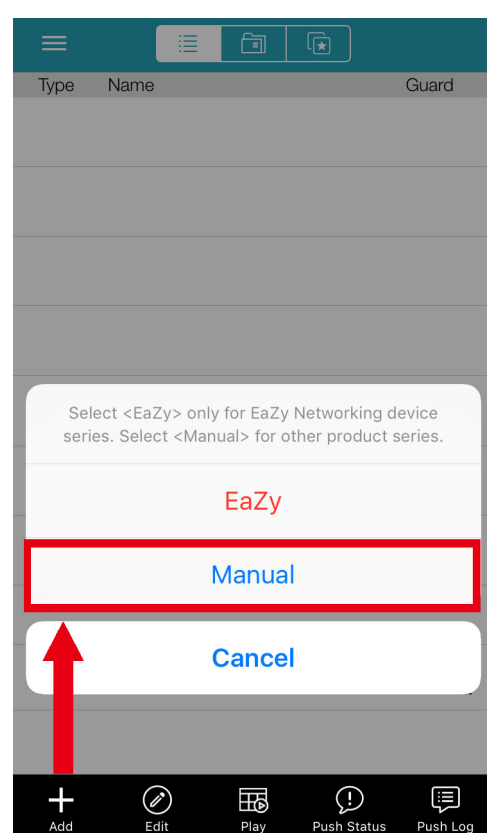

Step3: In the setting page, enter all the information needed to access this device in the **REQUIRED** column, and click **Get Type** to examine if the information you entered is correct. The device type will be detected properly.

Step4: (Optional) Configure the settings in the **OPTIONAL** column as needed.

The screenshot shows a configuration page with a teal header containing 'Cancel' and 'Save' buttons. Below the header, there are two sections: 'REQUIRED' and 'OPTIONAL'.
REQUIRED section:
 - Title: ezum demo
 - IP Address: avezum2.ddns.eagleeyes.1
 - Port: 8080
 - Username: ezum_demo
 - Password: masked with dots
 - A 'Get Type' button is shown with the detected device type 'DVR (16 CH)'.
OPTIONAL section:
 - Audio: A toggle switch is turned off, with 'CH1' and an info icon to its right.
 - Quality of priority: A toggle switch is turned on.
 - Multiple Channel Resolution: Two buttons, 'Low' and 'High', with 'High' selected.
 - Single Channel Source: A dropdown menu set to 'Sub Stream' with an info icon to its right.
 - Channel Title: A toggle switch is turned off.

Step5: Click **Save** to return to the address book. Enable **Guard** to receive Push Video.

The screenshot shows the address book interface with a teal header containing navigation icons. Below the header is a table with columns 'Type', 'Name', and 'Guard'.
 - The first row shows a device icon, the name 'ezum demo', and a 'Guard' toggle switch which is currently turned off. A red box highlights the toggle switch, and a red arrow points to it from below.
 - The bottom of the screen features a black navigation bar with five icons: 'Add', 'Edit', 'Play', 'Push Status', and 'Push Log'.

Step6: Click on the item you just added in the address book to access and check the live view.

APPENDIX 1 PRODUCT SPECIFICATIONS

■ 16CH Models w/ IVS

		Model 1	Model 2	Model 3
▼ Video				
Video System		NTSC / PAL (auto detection)		
Video Compression Format		H.265		
Video Signal		IP / TVI / CVI / Analog HD / 960H		
Video Input		16 pentabrid channels, within which IP channels are up to 8 channels	16 pentabrid channels, within which IP channels are up to 12 channels	
Video Input Interface	Analog Mode	Composite video signal 1 Vp-p 75Ω BNC		
	IP Mode	Ethernet, 1000 Base-T		
Video Output	BNC	YES (1080P display / Spot Monitor supported)		
	VGA	YES (1080P display / Spot Monitor supported)		
	HDMI	YES (4K2K display)		
Video Resolution	Analog Mode	5MP / 5MLITE / 4MP / 4MLITE / FHD (1080P) / HD / 960H / Frame / CIF		
	IP Mode	2592 x 1944 / 2048 x 1536 / 1920 x 1080 / 1280 x 720 / 720 x 480 / 352 x 240		
▼ Record & Backup				
Max. Recording Rate	Analog Mode	Up to 96 IPS @ 5MP Up to 128 IPS @ 4MP Up to 240 IPS @ FHD (1080P)		
	IP Mode	UP to 120 IPS @ 2592 x 1944 UP to 192 IPS @ 2048 x 1536 UP to 240 IPS @ 1920 x 1080	UP to 180 IPS @ 2592 x 1944 UP to 288 IPS @ 2048 x 1536 UP to 360 IPS @ 1920 x 1080	
Recording Mode		Manual / Timer / Motion / Alarm / Remote		
Playback Channel		16CH		
Quick Search		Time / Motion / Alarm search mode		
Backup Device		USB 2.0 drive / Network		
Regular Backup		YES (USB hard drive or FTP)		
▼ Audio				
Audio Input		4 (built-in) + 12 (external)	4	
Audio Output (Mono)		1		
▼ External I/O				
RS485		YES		
Alarm Input		8		
Alarm Output		1		
▼ General				
Hard Disk Storage		16TB SATA HDD x 4	16TB SATA HDD x 3	Either two 16TB SATA HDD installed in the recorder, or one 14TB SATA HDD installed and a disk array connected to the recorder via the eSATA interface
SATA Interface		YES		
eSATA Interface		NO		Expandable with a SATA to eSATA cable
Image Quality Setting		SUPER BEST / BEST / HIGH / NORMAL		
USB Mouse Control		YES		
Motion Detection Area		16 × 12 grids per channel		
Motion Detection Sensitivity		3 adjustable parameters for accurate detection		
Event Notification		Push Video / Push Status / FTP / E-Mail		
Event Pop-up & Preview		YES		

	Model 1	Model 2	Model 3
▼ General			
Scenario Setup	YES		
Picture Zoom	2X digital zoom		
PTZ Control	YES		
Key Lock (Password Protection)	YES		
User Level	4 user levels for different access privilege		
Video Loss Detection	YES		
Camera Title	Supports up to 25 letters		
Video Adjustable	Hue / Saturation / Contrast / Brightness		
Date Display Format	YY/MM/DD, DD/MM/YY & MM/DD/YY		
Daylight Saving	YES		
Power Source (±10%)	12V / 6A	12V / 4A	
Operating Temperature	10°C ~ 40°C (50°F~104°F)		
Operating Humidity	10% ~ 85%		
Dimensions (mm)**	432 × 90 × 326	375 x 273.8 x 77	
Net Weight (kg)	2.6	2.6	
▼ Network			
Ethernet	1000 Base-T. Supports remote control and live view via Ethernet		
Network Protocol	TCP/IP, PPPOE, DHCP and DDNS		
▼ Remote Surveillance from PC			
Compatible Operating System	Windows & MAC		
Compatible Program	Web Browser: Windows Edge, Internet Explorer, Google Chrome, Safari & Mozilla Firefox		
	CMS Lite: 32CH central management software for Windows OS		
Max. online users	20		
Web Transmitting Compression Format	H.265		
Network Live Audio	YES		
Remote Event Download & Playback	YES		
▼ Mobile Surveillance			
App	EagleEyes		
Compatible Devices	iOS & Android mobile devices		
Push Video	16CH		
Push Status	YES		
▼ Others			
EaZy Networking	YES		
IVS	4 channels in analog mode		
Spot Monitor Setup	YES (VGA & Composite)		
DCCS Support	YES		
Free DDNS service	YES		
Privacy Mask	YES		
Multiplex Operation	Live display / record / playback / backup / network operations		
System Recovery	System auto recovery after power failure		
Optional Peripherals	HDMI Matrix (HDM02) / USB Joystick (AVX102) / External audio kit (AUDIO12KIT)	HDMI Matrix (HDM02) / USB Joystick (AVX102)	HDMI Matrix (HDM02) / USB Joystick (AVX102) / SATA to eSATA cable (PWSC07F120200)

* The specifications are subject to change without notice.

** Dimensional tolerance: ±5mm

■ 16CH Models w/o IVS

		Model 4	Model 5	Model 6	Model 7
▼ Video					
Video System		NTSC / PAL (auto detection)			
Video Compression Format		H.265			
Video Signal		IP / TVI / CVI / Analog HD / 960H			
Video Input		16 pentabrid channels, within which IP channels are up to 2 channels			
Video Input Interface	Analog Mode	Composite video signal 1 Vp-p 75Ω BNC			
	IP Mode	Ethernet, 1000 Base-T			
Video Output	BNC	YES (1080P display / Spot Monitor supported)			
	VGA	YES (1080P display / Spot Monitor supported)	YES (1080P display / Spot Monitor supported / unavailable when video display is set to 4K2K)	YES (1080P display / Spot Monitor supported)	
	HDMI	YES (4K2K display)			
Video Resolution	Analog Mode	5MP / 5MLITE / 4MP / 4MLITE / FHD (1080P) / HD / 960H / Frame / CIF			
	IP Mode	2592 x 1944 / 2048 x 1536 / 1920 x 1080 / 1280 x 720 / 720 x 480 / 352 x 240			
▼ Record & Backup					
Max. Recording Rate	Analog Mode	Up to 96 IPS @ 5MP Up to 128 IPS @ 4MP Up to 240 IPS @ FHD (1080P)			
	IP Mode	UP to 30 IPS @ 2592 x 1944 (5MP) UP to 48 IPS @ 2048 x 1536 (3MP) UP to 60 IPS @ 1920 x 1080			
Recording Mode		Manual / Timer / Motion / Alarm / Remote			
Playback Channel		16CH			
Quick Search		Time / Motion / Alarm search mode			
Backup Device		USB 2.0 drive / Network			
Regular Backup		YES (USB hard drive or FTP)			
▼ Audio					
Audio Input		4		2	4
Audio Output (Mono)		1		1	1
▼ External I/O					
RS485		YES			
Alarm Input		NO	4		NO
Alarm Output		NO	1		NO
▼ General					
Hard Disk Storage		14TB SATA HDD x 2	16TB SATA HDD x 2 or 16TB SATA HDD x 1 + external disk array x 1 connected to the recorder via the eSATA interface	16TB SATA HDD x 1	16TB SATA HDD x 1 or external disk array x 1 connected to the recorder via the eSATA interface
SATA Interface		YES			
eSATA Interface		NO	Expandable with a SATA to eSATA cable	NO	Expandable with a SATA to eSATA cable
Image Quality Setting		SUPER BEST / BEST / HIGH / NORMAL			
USB Mouse Control		YES			
Motion Detection Area		16 × 12 grids per channel			
Motion Detection Sensitivity		3 adjustable parameters for accurate detection			
Event Notification		Push Video / Push Status / FTP / E-Mail			
Event Pop-up & Preview		YES			

	Model 4	Model 5	Model 6	Model 7
▼ General				
Scenario Setup	YES			
Picture Zoom	2X digital zoom			
PTZ Control	YES			
Key Lock (Password Protection)	YES			
User Level	4 user levels for different access privilege			
Video Loss Detection	YES			
Camera Title	Supports up to 25 letters			
Video Adjustable	Hue / Saturation / Contrast / Brightness			
Date Display Format	YY/MM/DD, DD/MM/YY & MM/DD/YY			
Daylight Saving	YES			
Power Source (±10%)	12V / 4A		12V / 3A	
Operating Temperature	10°C ~ 40°C (50°F~104°F)			
Operating Humidity	10% ~ 85%			
Dimensions (mm)**	319.5 x 254.9 x 52		260 x 235.7 x 48	319.5 x 254.9 x 52
Net Weight (kg)	1.7		1.2	1.7
▼ Network				
Ethernet	1000 Base-T. Supports remote control and live view via Ethernet			
Network Protocol	TCP/IP, PPPOE, DHCP and DDNS			
▼ Remote Surveillance from PC				
Compatible Operating System	Windows & MAC			
Compatible Program	Web Browser: Windows Edge, Internet Explorer, Google Chrome, Safari & Mozilla Firefox			
	CMS Lite: 32CH central management software for Windows OS			
Max. online users	20			
Web Transmitting Compression Format	H.265			
Network Live Audio	YES			
Remote Event Download & Playback	YES			
▼ Mobile Surveillance				
App	EagleEyes			
Compatible Devices	iOS & Android mobile devices			
Push Video	4CH	16CH		4CH
Push Status	YES			
▼ Others				
EaZy Networking	YES			
IVS	NO			
Spot Monitor Setup	YES (VGA & Composite)			
DCCS Support	YES			
Free DDNS service	YES			
Privacy Mask	YES			
Multiplex Operation	Live display / record / playback / backup / network operations			
System Recovery	System auto recovery after power failure			
Optional Peripherals	HDMI Matrix (HDM02) / USB Joystick (AVX102)	HDMI Matrix (HDM02) / USB Joystick (AVX102) / SATA to eSATA cable (PWSC07F120200)	HDMI Matrix (HDM02) / USB Joystick (AVX102)	HDMI Matrix (HDM02) / USB Joystick (AVX102) / SATA to eSATA cable (PWSC07F120200)

* The specifications are subject to change without notice.

** Dimensional tolerance: ±5mm

■ 8CH Models

		Model 8	Model 9	Model 10	Model 11
▼ Video					
Video System		NTSC / PAL (auto detection)			
Video Compression Format		H.265			
Video Signal		IP / TVI / CVI / Analog HD / 960H			
Video Input		8 pentabrid channels + 1 IP channel	8 pentabrid channels	8 pentabrid channels, within which IP channels are up to 2 channelsd	
Video Input Interface	Analog Mode	Composite video signal 1 Vp-p 75Ω BNC			
	IP Mode	Ethernet, 1000 Base-T			
Video Output	BNC	YES (1080P display / Spot Monitor supported)			
	VGA	YES (1080P display / Spot Monitor supported)	YES* (1080P display / Spot Monitor supported)	YES (1080P display / Spot Monitor supported)	YES* (1080P display / Spot Monitor supported)
	HDMI	YES (4K2K display)			
Video Resolution	Analog Mode	5MP / 5MLITE / 4MP / 4MLITE / FHD (1080P) / HD / 960H / Frame / CIF	8MP / 5MP / 5MLITE / 4MP / 4MLITE / FHD (1080P) / HD / 960H / Frame / CIF	5MP / 5MLITE / 4MP / 4MLITE / FHD (1080P) / HD / 960H / Frame / CIF	
	IP Mode	2592 x 1944 / 2048 x 1536 / 1920 x 1080 / 1280 x 720 / 720 x 480 / 352 x 240	3264 x 2448 / 2592 x 1944 / 2048 x 1536 / 1920 x 1080 / 1280 x 720 / 720 x 480 / 352 x 240	2592 x 1944 / 2048 x 1536 / 1920 x 1080 / 1280 x 720 / 720 x 480 / 352 x 240	
▼ Record & Backup					
Max. Recording Rate	Analog Mode	Up to 48 IPS @ 5MP Up to 64 IPS @ 4MP Up to 120 IPS @ 1080P	Up to 60 IPS @ 8MP Up to 80 IPS @ 5MP Up to 120 IPS @ 4MP Up to 240 IPS @ FHD (1080P)	Up to 48 IPS @ 5MP Up to 64 IPS @ 4MP Up to 120 IPS @ 1080P	
	IP Mode	UP to 63 IPS @ 5MP UP to 90 IPS @ 3MP UP to 135 IPS @ 1080P	UP to 96 IPS @ 8MP UP to 120 IPS @ (5MP) UP to 240 IPS @ 3MP UP to 240 IPS @ 1080P	UP to 30 IPS @ 5MP UP to 50 IPS @ 3MP UP to 60 IPS @ 1080P	
Recording Mode		Manual / Timer / Motion / Alarm / Remote			
Playback Channel		8CH			
Quick Search		Time / Motion / Alarm search mode			
Backup Device		USB 2.0 drive / Network			
Regular Backup		YES (USB hard drive or FTP)			
▼ Audio					
Audio Input		4			
Audio Output (Mono)		1			
▼ External I/O					
RS485		YES			
Alarm Input		4			
Alarm Output		1			
▼ General					
Hard Disk Storage		14TB SATA HDD x 1 or external disk array x 1 connected to the recorder via the eSATA interface	16TB SATA HDD x 2 or 16TB SATA HDD x 1 + external disk array x 1 connected to the recorder via the eSATA interface	14TB SATA HDD x 1 or external disk array x 1 connected to the recorder via the eSATA interface	
SATA Interface		YES			
eSATA Interface		Expandable with a SATA to eSATA cable			
Image Quality Setting		SUPER BEST / BEST / HIGH / NORMAL			
USB Mouse Control		YES			

	Model 8	Model 9	Model 10	Model 11
▼ General				
Motion Detection Area	16 × 12 grids per channel			
Motion Detection Sensitivity	3 adjustable parameters for accurate detection			
Event Notification	Push Video / Push Status / FTP / E-Mail			
Event Pop-up & Preview	YES			
Scenario Setup	YES			
Picture Zoom	2X digital zoom			
PTZ Control	YES			
Key Lock (Password Protection)	YES			
User Level	4 user levels for different access privilege			
Video Loss Detection	YES			
Camera Title	Supports up to 25 letters			
Video Adjustable	Hue / Saturation / Contrast / Brightness			
Date Display Format	YY/MM/DD, DD/MM/YY & MM/DD/YY			
Daylight Saving	YES			
Power Source (±10%)	12V / 2A	12V / 4A	12V / 2A	
Operating Temperature	10°C ~ 40°C (50°F~104°F)			
Operating Humidity	10% ~ 85%			
Dimensions (mm)**	260 x 235.7 x 48	219.5 x 254.9 x 52	260 x 235.7 x 48	
Net Weight (kg)	1.3	--	1.35	
▼ Network				
Ethernet	1000 Base-T. Supports remote control and live view via Ethernet			
Network Protocol	TCP/IP, PPPOE, DHCP and DDNS			
▼ Remote Surveillance from PC				
Compatible Operating System	Windows & MAC			
Compatible Program	Web Browser: Windows Edge, Internet Explorer, Google Chrome, Safari & Mozilla Firefox			
	CMS Lite: 32CH central management software for Windows OS			
Max. online users	20			
Web Transmitting Compression Format	H.265			
Network Live Audio	YES			
Remote Event Download & Playback	YES			
▼ Mobile Surveillance				
App	EagleEyes			
Compatible Devices	iOS & Android mobile devices			
Push Video	8CH		2CH	8CH
Push Status	YES			
▼ Others				
EaZy Networking	YES			
IVS	4 channels in analog mode	NO		
Spot Monitor Setup	YES (VGA & Composite)			
DCCS Support	YES			
Free DDNS service	YES			
Privacy Mask	YES			
Multiplex Operation	Live display / record / playback / backup / network operations			
System Recovery	System auto recovery after power failure			
Optional Peripherals	HDMI Matrix (HDM02) / USB Joystick (AVX102) / SATA to eSATA cable (PWSC07F120200)			

* Unavailable when video display is set to 4K2K ** Dimensional tolerance: ±5mm *** The specifications are subject to change without notice.

■ 4CH Models

		Model 12	Model 13	Model 14
▼ Video				
Video System		NTSC / PAL (auto detection)		
Video Compression Format		H.265		
Video Signal		IP / TVI / CVI / Analog HD / 960H		
Video Input		4 pentabrid channels, within which IP channels are up to 4 channels	4 pentabrid channels, within which IP channels are up to 2 channels	
Video Input Interface	Analog Mode	Composite video signal 1 Vp-p 75Ω BNC		
	IP Mode	Ethernet, 1000 Base-T		
Video Output	BNC	YES (1080P display)		
	VGA	YES (1080P display)	YES (1080P display / unavailable when video display is set to 4K2K)	
	HDMI	YES (4K2K display)		
Video Resolution	Analog Mode	5MP / 5MLITE / 4MP / 4MLITE / FHD (1080P) / HD / 960H / Frame / CIF		
	IP Mode	2592 x 1944 / 2048 x 1536 / 1920 x 1080 / 1280 x 720 / 720 x 480 / 352 x 240		
▼ Record & Backup				
Max. Recording Rate	Analog Mode	Up to 24 IPS @ 5MP Up to 32 IPS @ 4MP Up to 60 IPS @ FHD (1080P)		
	IP Mode	UP to 28 IPS @ 5MP UP to 40 IPS @ 3MP UP to 60 IPS @ 1080P	UP to 30 IPS @ 5MP UP to 50 IPS @ 3MP UP to 60 IPS @ 1080P	
Recording Mode		Manual / Timer / Motion / Alarm / Remote		
Playback Channel		4CH		
Quick Search		Time / Motion / Alarm search mode		
Backup Device		USB 2.0 drive / Network		
Regular Backup		YES (USB hard drive or FTP)		
▼ Audio				
Audio Input		4		
Audio Output (Mono)		1		
▼ External I/O				
RS485		YES		
Alarm Input		4		
Alarm Output		1		
▼ General				
Hard Disk Storage		14TB SATA HDD x 1 or external disk array x 1 connected to the recorder via the eSATA interface		
SATA Interface		YES		
eSATA Interface		Expandable with a SATA to eSATA cable		
Image Quality Setting		SUPER BEST / BEST / HIGH / NORMAL		
USB Mouse Control		YES		
Motion Detection Area		16 × 12 grids per channel		
Motion Detection Sensitivity		3 adjustable parameters for accurate detection		
Event Notification		Push Video / Push Status / FTP / E-Mail		
Event Pop-up & Preview		YES		
Scenario Setup		YES		
Picture Zoom		2X digital zoom		
PTZ Control		YES		

	Model 12	Model 13	Model 14
▼ General			
Key Lock (Password Protection)	YES		
User Level	4 user levels for different access privilege		
Video Loss Detection	YES		
Camera Title	Supports up to 25 letters		
Video Adjustable	Hue / Saturation / Contrast / Brightness		
Date Display Format	YY/MM/DD, DD/MM/YY & MM/DD/YY		
Daylight Saving	YES		
Power Source (±10%)	12V / 2A		
Operating Temperature	10°C ~ 40°C (50°F~104°F)		
Operating Humidity	10% ~ 85%		
Dimensions (mm)**	260 x 235.7 x 48		
Net Weight (kg)	1.3		
▼ Network			
Ethernet	1000 Base-T. Supports remote control and live view via Ethernet		
Network Protocol	TCP/IP, PPPOE, DHCP and DDNS		
▼ Remote Surveillance from PC			
Compatible Operating System	Windows & MAC		
Compatible Program	Web Browser:	Windows Edge, Internet Explorer, Google Chrome, Safari & Mozilla Firefox	
	CMS Lite:	32CH central management software for Windows OS	
Max. online users	20		
Web Transmitting Compression Format	H.265		
Network Live Audio	YES		
Remote Event Download & Playback	YES		
▼ Mobile Surveillance			
App	EagleEyes		
Compatible Devices	iOS & Android mobile devices		
Push Video	4CH	1CH	4CH
Push Status	YES		
▼ Others			
EaZy Networking	YES		
IVS	4 channels in analog mode	NO	
Spot Monitor Setup	NO		
DCCS Support	YES		
Free DDNS service	YES		
Privacy Mask	YES		
Multiplex Operation	Live display / record / playback / backup / network operations		
System Recovery	System auto recovery after power failure		
Optional Peripherals	HDMI Matrix (HDM02) / USB Joystick (AVX102) / SATA to eSATA cable (PWSC07F120200)		

* The specifications are subject to change without notice.

** Dimensional tolerance: ±5mm

APPENDIX 2 PUSH VIDEO CONFIGURATION

Note: This function is for selected models only.

A2.1 Alarm Sensor Connection

Connect the alarm sensor, such as magnetic contacts, to the alarm-in port on the rear panel. Alarm-in 1 corresponds to video channel 1, alarm-in 2 corresponds to video channel 2, and so on.

Note: The voltage restriction for alarm-in device connection is under DC24V 1A.

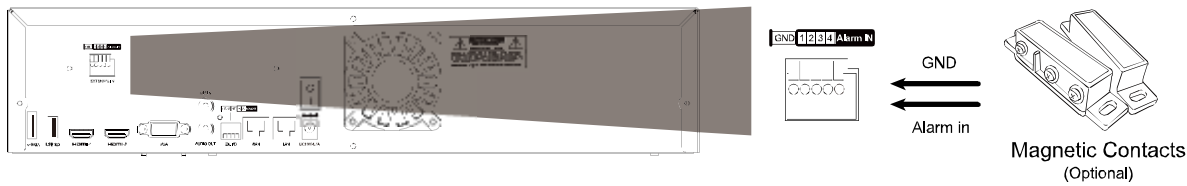

Then, go to **MENU → PERIPHERAL → LOCAL ALARM IN** to choose how the alarm sensor works (**OFF / N.C. / N.O.**), and go to **MENU → CAMERA → DETECTION** to enable **MOTION**.

If the connected camera is our brand's camera with alarm I/O support, you can also connect the alarm sensor to the camera.

Note: Please check the user manual of the camera to know voltage restriction for alarm-in device connection.

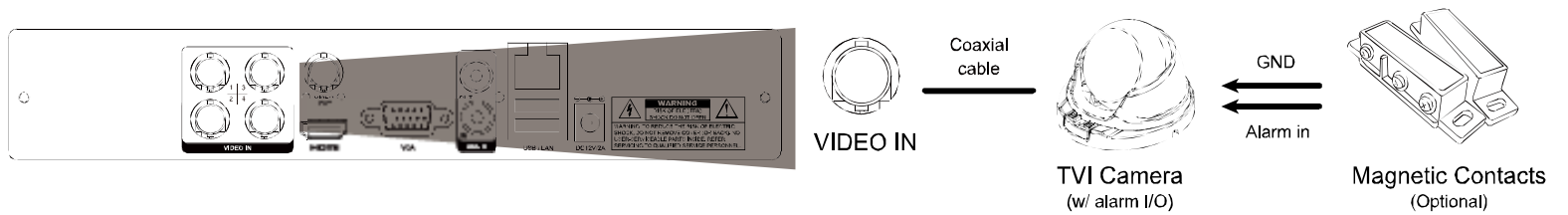

Then, go to **MENU → CAMERA → DETECTION** and make sure:

- MOTION is set to **ON**.
- ALARM** is configured (**N.C. / N.O.**) when an external alarm device is connected, or **INTERNAL ALARM** is set to **ON** when the connected camera has a PIR sensor built-in.

DETECTION							
CHANNEL TITLE	ALARM	INTERNAL ALARM	SENSITIVITY	MOTION	AREA	ADVANCED CONFIG	
CH1	OFF ✓	ON	EDIT	ON	EDIT		
CH2	N.C. ✓	OFF	EDIT	ON	EDIT		
CH3	N.O. ✓	OFF	EDIT	OFF	EDIT		
CH4	OFF ✓	OFF	EDIT	OFF	EDIT		
							APPLY

A2.2 Configuration

Before configuring Push Video, make sure:

1. The system is set up as described in “2. CONNECTION” at page 3.
2. This recorder is connected to Internet.
3. You’ve installed the app, EagleEyes, on your iOS or Android mobile devices.
For details, please refer to “6.3 Mobile Devices” at page 59.

Step1: Go to **MENU** → **SCENARIO**, and enable the necessary rules:

If your alarm sensor is...	Please enable ...
External alarm sensor	1. PUSH VIDEO TRIGGERED BY EXTERNAL ALARM 2. MOTION DETECTION ON WHEN GUARD ON
PIR sensor built-in	1. PUSH VIDEO TRIGGERED BY BUILT-IN PIR SENSOR 2. MOTION DETECTION ON WHEN GUARD ON 3. INTERNAL ALARM (PIR) DETECTION ON WHEN GUARD ON

Step2: Open EagleEyes, and add this recorder to the EagleEyes address book.

A2.3 Enable Push Video

A2.3.1 From iOS Mobile Device

Step1: In the iPhone / iPad main menu, select **Settings** → **Notifications**. Select **EagleEyes**, and make sure the notification is set to on.

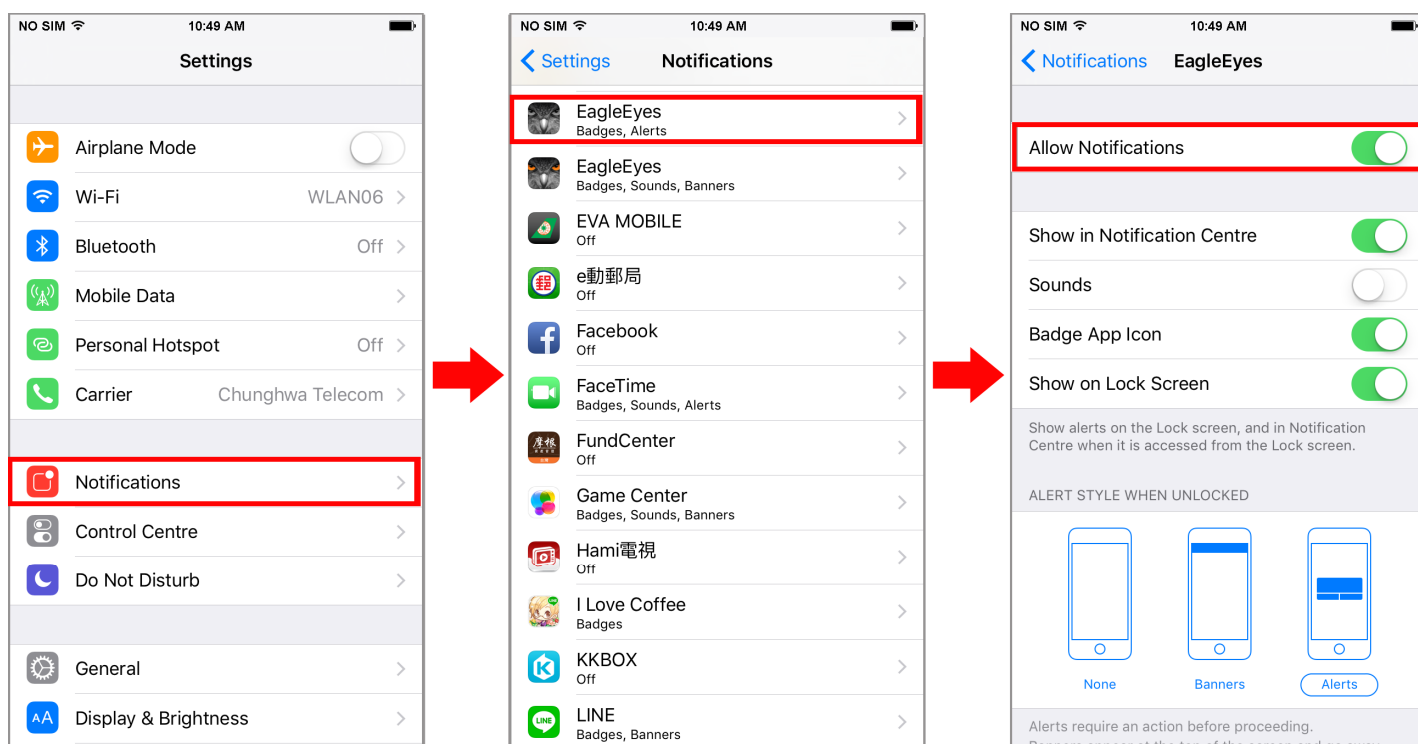

Step2: Open **EagleEyes**, and switch **Guard** to **ON**. You'll receive the message indicating that Push Video is on.

Step3: Return to the main page or standby page. You'll receive event notifications when there's an alarm event. Follow the on-screen instruction to immediately play the recorded clip.

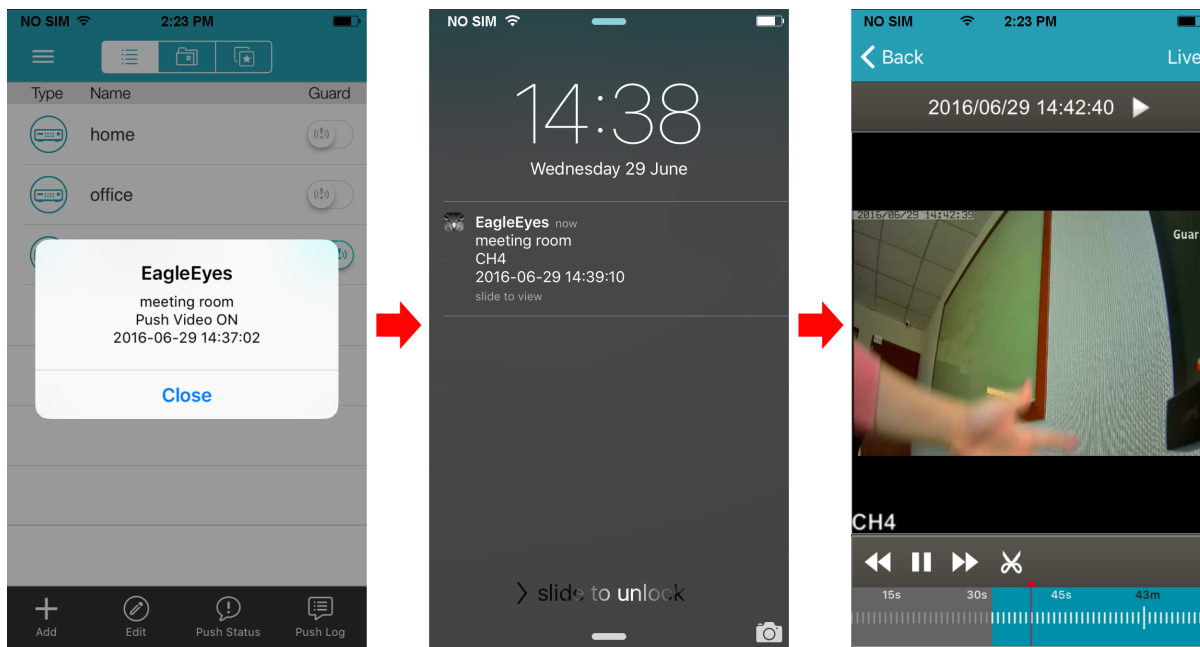

A2.3.2 From Android Mobile Device

Step1: Open **EagleEyes**, and switch **Guard** from **OFF** to **ON**. You'll receive the message indicating that Push Video is on.

Step2: Return to the main page or standby page. You'll receive event notifications when there's an alarm event. Follow the on-screen instruction to immediately play the recorded clip.

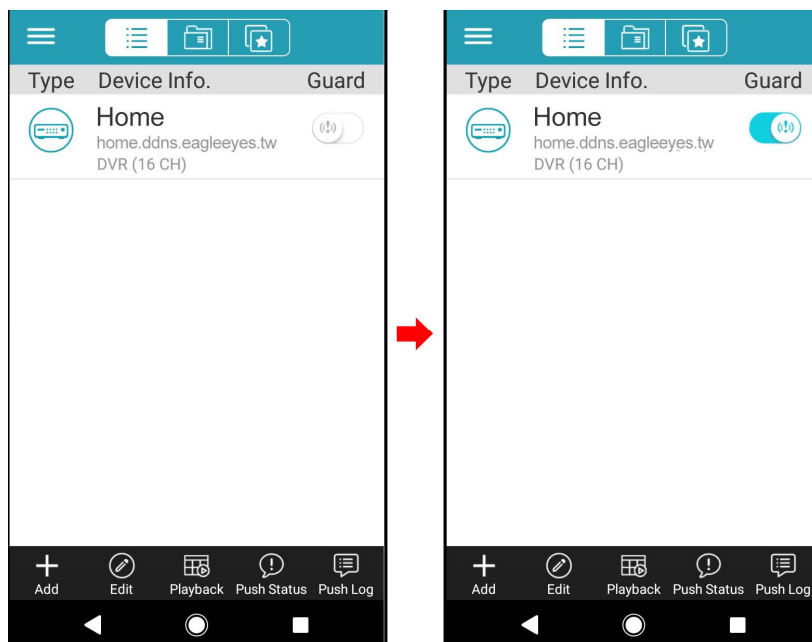

APPENDIX 3 COMPATIBLE USB FLASH DRIVE LIST

Please upgrade the firmware of the recorder to the latest version to ensure the accuracy of the following table. If the USB flash drive is NOT supported by the recorder, you will see  on the screen.

Note: Please use your PC to format the USB flash drive as "FAT32".

Note: You can backup up to 2GB video data for one-time USB backup. To backup more data, please set the time & channel(s) you want, and start USB backup again.

MANUFACTURER	MODEL	CAPACITY
Transcend	JFV35	4GB
	JFV30	8GB
Kingston	DataTraveler	1GB
PQI	U172P	4GB
Apacer	AH320	2GB
	AH320A	8GB
	AH220	1GB
	AH320	4GB
A-data	RB-18	1GB
Sandisk	Cruzer Micro	2GB
	Cruzer Micro	4GB
	Cruzer4-pk	2GB
Netac	U208	1GB
MSI	F200	4GB
SONY	Micro Vault Tiny 2GB	2GB
	Micro Vault Tiny 4GB	4GB
	Micro Vault Tiny	1GB

APPENDIX 4 COMPATIBLE HARD DISK LIST

Please upgrade the firmware of the device to the latest version to ensure the accuracy of the following table.

Note: It's necessary to install a hard disk first before firmware upgrade to ensure the upgrade process works properly.

Note: To use a green hard disk, use **ONLY** the hard disk designed especially for surveillance to ensure the device works properly.

Seagate*			
MODEL	CAPACITY	MODEL	CAPACITY
ST1000VX001	1TB	ST6000VX0011	6TB**
ST1000VX005	1TB	ST6000NM0024	6TB**
ST2000VX004	2TB	ST6000VX001	6TB**
ST3000VM002	3TB	ST8000VX002	8TB**
ST3000VX004	3TB	ST8000VX0022	8TB**
ST3000VX005	3TB	ST8000VE000	8TB**
ST4000VM000	4TB	ST8000VX004	8TB**
ST4000VX000	4TB	ST100000VX0004	10TB**
ST4000VX002	4TB	ST10000VX0004	10TB**
ST4000VX007	4TB	ST10000VE0004	10TB**
ST4000VX005	4TB	ST14000VX0008	14TB**
ST6000VX0001	6TB**	ST16000VE000	16TB**
WD			
MODEL	CAPACITY	MODEL	CAPACITY
WD10PURX	1TB	WD30EFRX	3TB
WD20PURX	2TB	WD40PURX	4TB
WD20EURS	2TB	WD40EURX	4TB
WD20EURX	2TB	WD60EURX	6TB**
WD20EFRX	2TB	WD60PURX	6TB**
WD2002FAEX	2TB	WD6001FFWX	6TB**
WD30PURX	3TB	WD6001FSYZ	6TB**
WD30EURX	3TB	WD121PURZ	12TB**
TOSHIBA			
MODEL	CAPACITY	MODEL	CAPACITY
DT01ACA050	500GB	MD03ACA200V	2TB
DT01ABA050V	500GB	DT01ABA300V	3TB
DT01ACA100	1TB	DT01ACA300	3TB
DT01ABA100V	1TB	MD03ACA300V	3TB
DT01ACA200	2TB	MD03ACA400V	4TB
DT01ABA200V	2TB	MD04ABA500V	5TB**

* To know more details about SRS and its related support and service, please contact your local Seagate representative directly.

** Please be advised to pay attention to the heat dissipation of the hard disk which is over 4TB because it might generate much heat during operation. It's recommended that ambient temperature is not over 35°C.

APPENDIX 5 BATTERY REPLACEMENT

The time reset after power failure, for example, caused by a power outage, will cause the disorder of the recorded data, and users may have problems in searching the event clip they want. To keep the device time from resetting, a non-chargeable lithium battery, CR2032, is installed in the device.

However, the device time might still get reset when the battery is low or even running out of power. If so, please replace the device battery, CR2032, **right away** as instructed below.

➤ How to replace CR2032

Note: The lithium battery, CR2032, is a non-chargeable battery, and should be purchased separately. Please replace only with the same or equivalent type battery in case of danger.

Step1: Stop all recording **immediately** to prevent the disorder of the recorded data. Then, back up the recorded data if necessary.

Step2: Power off the device, and disconnect the power.

Step3: Remove the rear panel of the device to find the battery on the mainboard.

Step4: Push the release as indicated below to remove the battery.



Type1

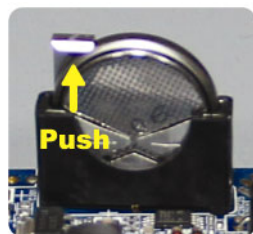

Type 2

Step5: Get a new battery and install it to its slot on the main board.

- For Type 1, install it with the side of “CR2032” facing up as shown above.
- For Type 2, install it without the side of “CR2032” facing you as shown above.

Step6: Replace the rear panel and connect to power.

Step7: Set the date & time, and resume recording.

APPENDIX 6 EAZY NETWORKING



EaZy Networking is a free P2P cloud service to connect AVTECH devices to the Internet automatically by plug-and-play, enabling you to check the live view via your mobile device or laptop at anytime.

In most cases, the device is connected via P2P. Connection via the relay server is only applied to some complex environments such as the private IP-based network environment used by a large enterprise. There is no speed limitation of P2P connection. To obtain stable transmission, it's recommended to purchase our data plan of 1GB or 7GB. Each device will enclose a 2GB data plan for a free trial.

EaZy Networking could be configured via EagleEyes on an iOS / android device, or via Internet Explorer.

Note: The instructions below explain how to configure via the free mobile app, EagleEyes. To know how to configure via Internet Explorer, please check the complete user manual.

Before using this function, make sure:

- This recorder is connected to a switch or router, and the switch or router is ready for Internet connection.
- The network icon on the bottom right corner is , not .
- You have an iOS / Android mobile device with EagleEyes installed.

A8.1 Via EagleEyes on iOS / Android Device

A8.1.1 Recorder Setup

Step1: Go to **MENU** → **NETWORK** → **WAN**. Set **NETWORK TYPE** to **DHCP**, and make sure the network icon on the bottom right corner is changed from  to .

Note: **DHCP** allows your router to assign an IP address for your device automatically. There are also **STATIC** and **PPPOE** to choose for the network type. Please choose the one needed for your network environment and get the information needed from your installer or network service provider.

WAN	WAN	
LAN	NETWORK TYPE	DHCP <input type="button" value="v"/>
DDNS	IP	192.168.1.112
E-MAIL	GATEWAY	192.168.1.254
FTP	NETMASK	255.255.255.0
EaZy	PRIMARY DNS	168.95.1.1
	SECONDARY DNS	139.175.55.244
	PORT	88
	INTERNET AVAILABILITY ADDRESS	www.google.com
	MAC 00:0E:53:00:13:77	

Step2: In the same menu, select **EaZy**. Enable EaZy Networking, and leave this page open. You'll need to scan the QR code later.

WAN	EaZy	
LAN	ENABLE EAZY NETWORKING	ON
DDNS	 MAC: 000e53eca7b4 UUID: E736DCBF-D4BB-4CA8-86FD-62658E2ECEC1 PORT: 80 EAZY NETWORKING OFFLINE	
E-MAIL		
FTP		
EaZy		

A8.1.2 EagleEyes Setup

Two options can be chosen for EaZy Networking: **EaZy** and **QR Code**. **EaZy** is used for both recorders and IP cameras while **QR Code** is used only for recorders.

When a device is configured to the internet via **EaZy**, the person who configures the device has the administrator permission of this device and also has the power to assign who can access the device remotely, by the web browser of Internet Explorer or the mobile app of EagleEyes.

When a device is configured to the internet via **QR Code**, everyone has the right to access the device as long as he/she is able to scan the QR code of the device. However, he/she can only access the device via the mobile app of EagleEyes. Internet Explorer is not supported.

By QR Code

Step1: Open EagleEyes on your mobile device, and select **Add** on the bottom. Then, click **QR Code**.

Step2: Scan the QR code shown on your recorder, and enter the title of this device and its user name and password.

Step3: Make sure you see the device type when you tap **Get Type**. If not, the device is not connected properly. Then, Tap **Apply** to complete the process and you're ready to see the live view.

Note: For the first time to connect your device to the internet, the default user name and password are both **admin**. If it's been configured before, make sure you've known its current user name and password since they may be changed for security purpose.

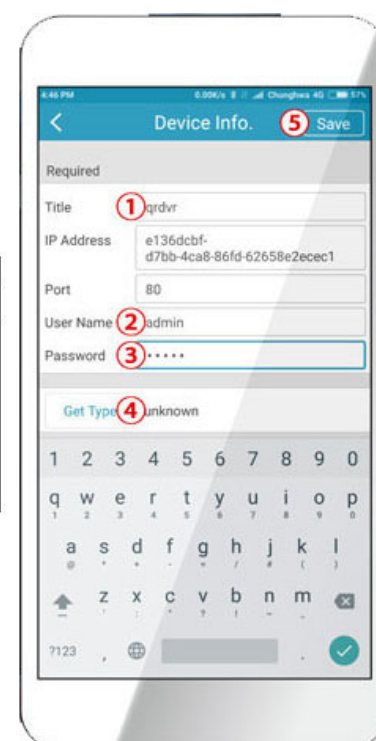
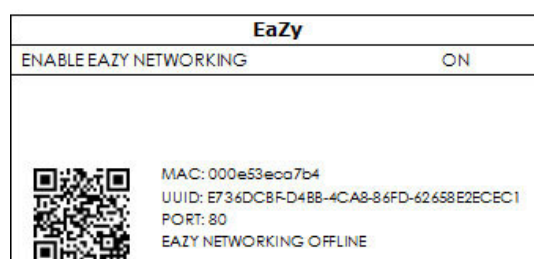
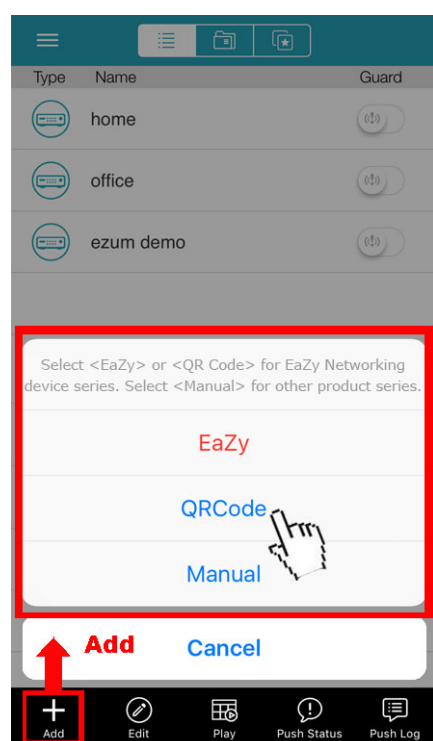

Step1: Go to **MENU** → **NETWORK** → **WAN**. Set **NETWORK TYPE** to **DHCP**, and make sure the network icon on the bottom right corner is changed from  to .

By QR Code

Step1: Open EagleEyes on your mobile device, and select “...” on the top left corner in the address book. Then, click **EaZy**.

Step2: Click **Login** and register an account for “Cloud Service”. If you've got an account, please just log in.

Step3: Go back to the address book and click **+** to add a new device. Select **EaZy**, and choose the recorder icon to continue.

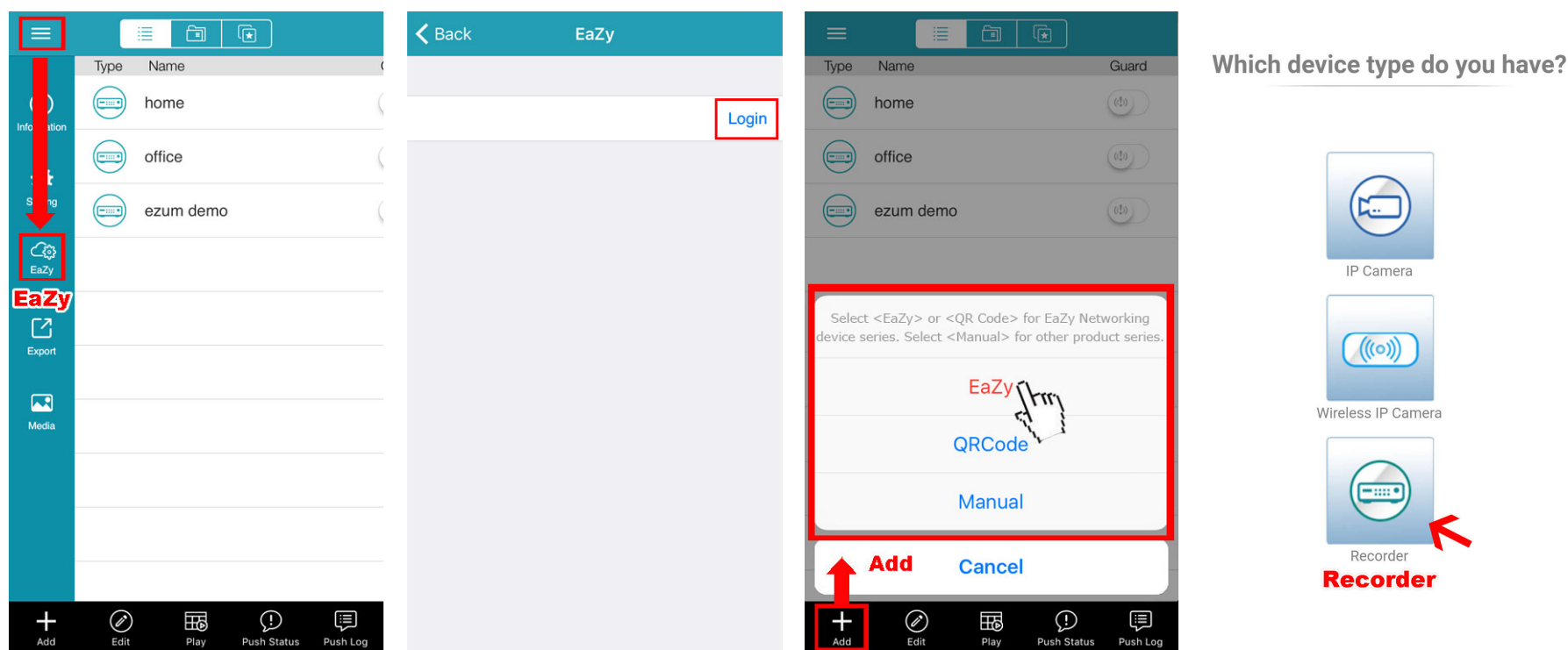

Step4: Click  in the section of **MAC address** to open the QR code scan page, and scan the QR code on the recorder screen mentioned in Step2. The MAC address will be filled automatically. Fill in the Captcha code manually, and click **Apply**.

Step5: Follow the on-screen instruction to finish the rest of the settings, and see if this device is added successfully to the address book as a cloud device.

At the same time, you'll be prompted to confirm if you want to remove the default user name and password.

- When the default user name and password are removed, you can **ONLY** use the user name and password of the cloud service to access this recorder locally and remotely. If you forget the user name and password of the cloud service, you could only reset the recorder and do all configurations again.
- When the default user name and password are kept, other people might be able to access this recorder if they know the default user name and password of this recorder.

Confirm if you want to keep the default account to continue, and return to the address book. You'll see the newly-added device in the address with a cloud icon on it.

Find the MAC address sticker on the rear panel or bottom of your device.

000E53E62B26

MAC address:
000E53E62B26

Ex.: "000E53E62B26"

Captcha: 88D76Y

Scan QR code

Back Apply

Step6: Click the newly-added device and see if you could access successfully.

A8.1.2 Checking Remaining Data Allowance

Step1: Log into the cloud service.

Step2: Select **Details** to go to account information, and select **Available Data Allowance**.

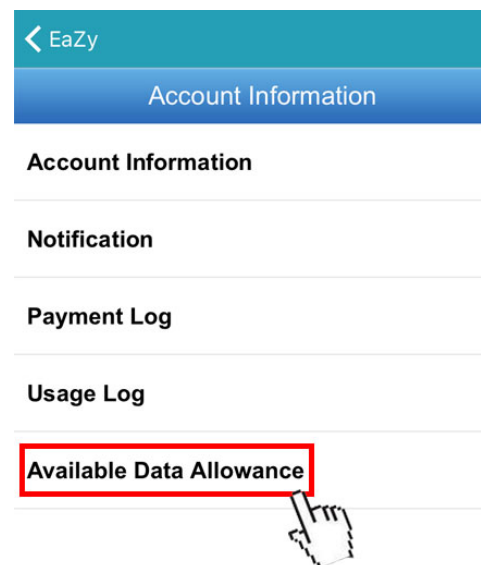
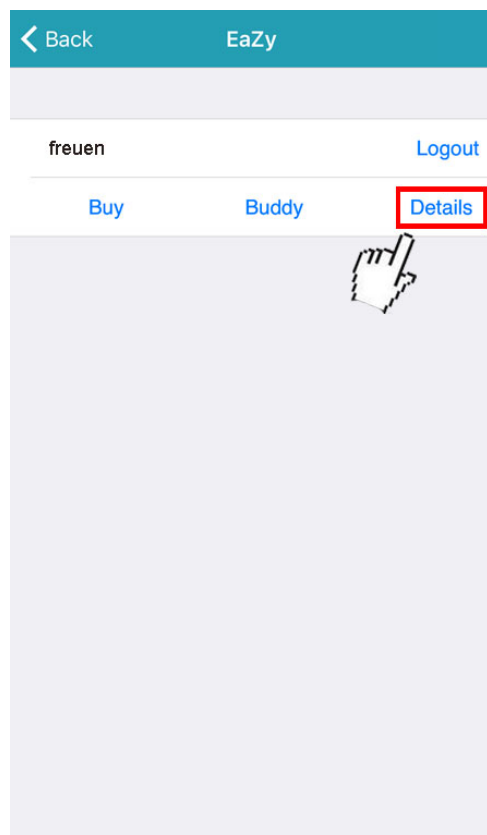

A8.1.3 Sharing Cloud Device Access with Other Account(s)

Note: One cloud device could be shared up to 30 cloud accounts, but the access to the device might be failed because it is still restricted to the maximum online user setup of the device.

Step1: Log into the cloud service.

Step2: Select **Buddy** to go to the buddy sharing page. Then, choose the device you want to share with, and switch from **OFF** to "Share".

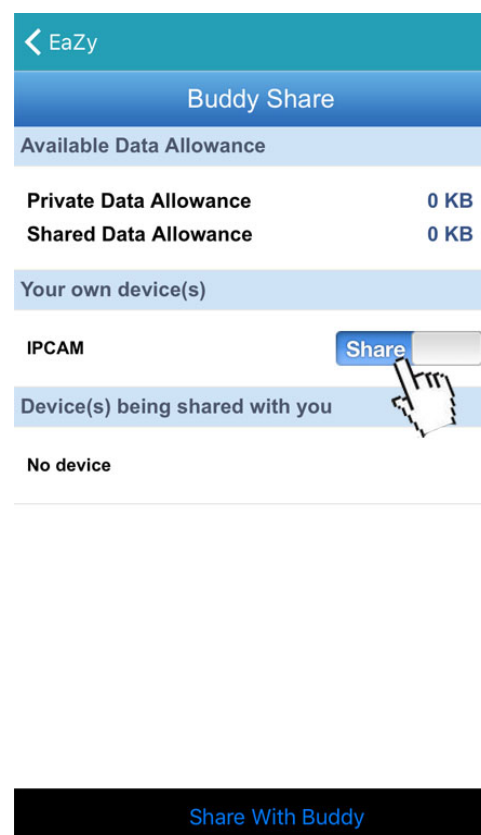
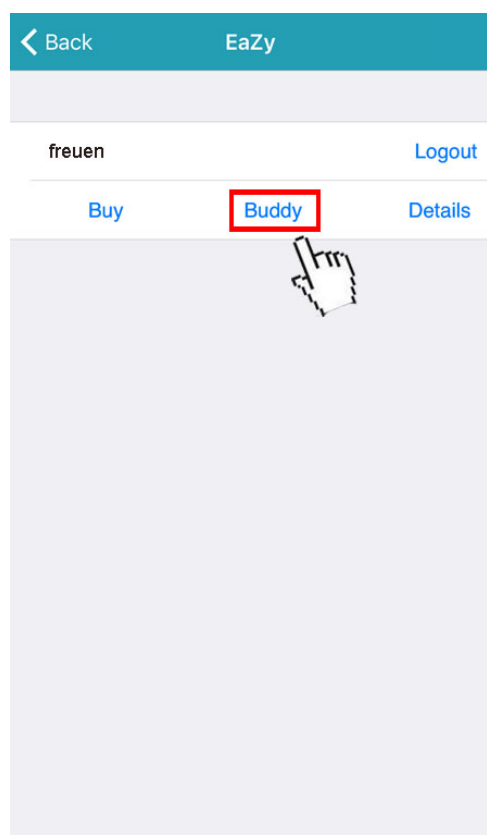

Step3: Choose the device you want to share with.

Step4: Enter the cloud account or the E-mail registered by the account, and select **Add**.

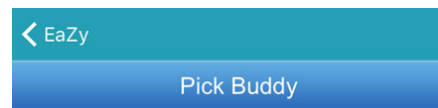
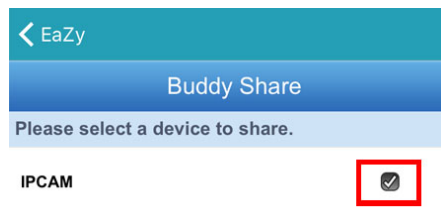

Please enter a buddy's account or Email, or you could pick one from 'Buddy List' alternatively.



Step4: Check again the account with which you want to share your cloud device, and select “**Next**” to confirm and continue.

Step5: Specify the access permission of the specified account, which account’s data allowance should be consumed after access successfully, and how long the account is allowed to stay after access successfully.

➤ Who should pay data allowance:

Who should pay data allowance	The order to consume data allowance
I	The free data allowance provided by the device -> The additional data allowance shared to other account(s) by the owner -> The additional data allowance of the device’s owner -> The data allowance shared to other account(s) by the buddy
Buddy	The additional data allowance of the buddy -> The data allowance shared with other account(s) by the buddy

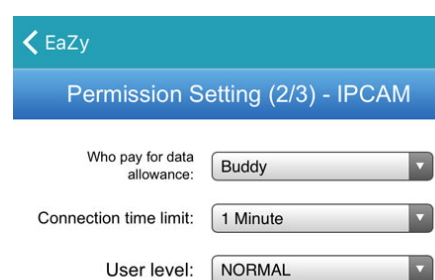
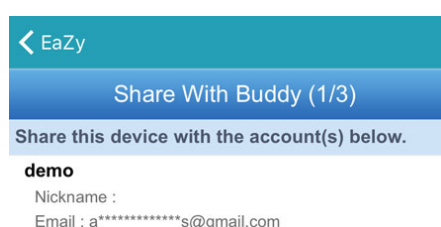

SUPERVISOR :
Can configure and customize all settings, hear audio stream, and receive Push Video / Push Status notifications.

POWER USER :
Can do remote playback.

NORMAL :
Can perform basic control.

GUEST :
Can only see live stream.



Step6: Check again the configurations you made for the account to which you want to share your cloud device, and select **Share!** to confirm.

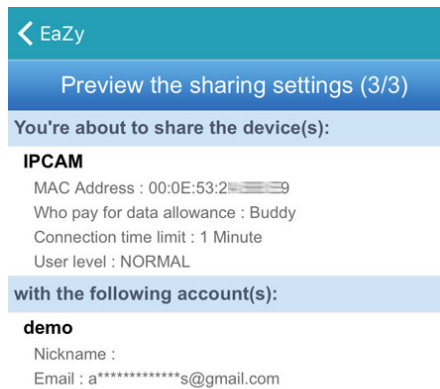

Step7: (Optional) Configure the data allowance shared to other accounts to use.

Step8: Return to the address book of EagleEyes. You'll see the device being shared is marked with an icon of two people.

A8.2 Via Internet Explorer on PC / Laptop

Note: EaZy Networking setup via a web browser is only available on Internet Explorer.

A8.2.1 Setup

Step1: Go to **MENU** → **NETWORK** → **WAN**. Set **NETWORK TYPE** to **DHCP**, and make sure the network icon on the bottom right corner is changed from  to .

Note: **DHCP** allows your router to assign an IP address for your device automatically. There are also **STATIC** and **PPPOE** to choose for the network type. Please choose the one needed for your network environment and get the information needed from your installer or network service provider.

WAN	WAN	
LAN	NETWORK TYPE	DHCP <input type="button" value="v"/>
DDNS	IP	192.168.1.112
E-MAIL	GATEWAY	192.168.1.254
FTP	NETMASK	255.255.255.0
EaZy	PRIMARY DNS	168.95.1.1
	SECONDARY DNS	139.175.55.244
	PORT	88
	INTERNET AVAILABILITY ADDRESS	www.google.com
	MAC 00:0E:53:00:13:77	

Step2: In the same menu, select **EaZy**. Enable EaZy Networking, and leave this page open. You'll need to scan the QR code later.

WAN	EaZy
LAN	
DDNS	
E-MAIL	
FTP	
EaZy	

ENABLE EAZY NETWORKING	ON
 <div style="display: inline-block; vertical-align: middle; margin-left: 10px;"> <p>MAC: 000e53eca7b4</p> <p>UUID: E736DCBF-D4BB-4CA8-86FD-62658E2ECEC1</p> <p>PORT: 80</p> <p>EAZY NETWORKING OFFLINE</p> </div>	

Step3: Open Internet Explorer on a PC / laptop, and enter <https://ez.eagleeyes.tw>.

In the login page, register an account for "Cloud Service". If you've got an account, please just log in.

Note: You PC must be connected to Internet.

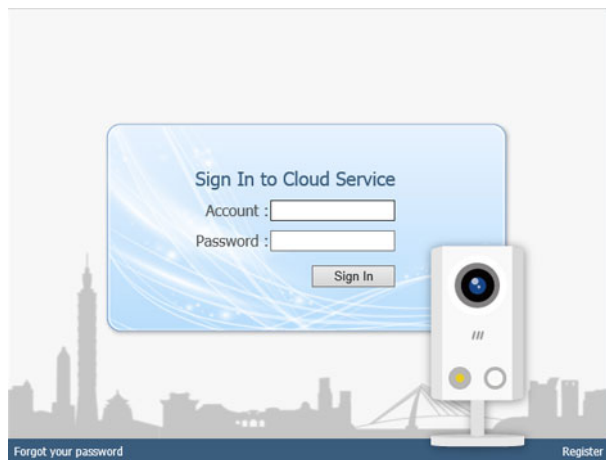

Step4: Click + on the left pane, and you'll be prompted to install plugins: **EaZy Control** and **EaZy Wizard**. Please follow the instructions to install these two plugins to ensure the service works properly.

Note: If you're not prompted to install the plugin, please lower the security level of Internet Explorer, and try to log into the cloud service again.

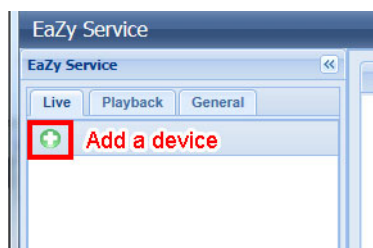

Step5: Enable EaZy Wizard, and click **Start** to go to the login page. Log into the cloud service.

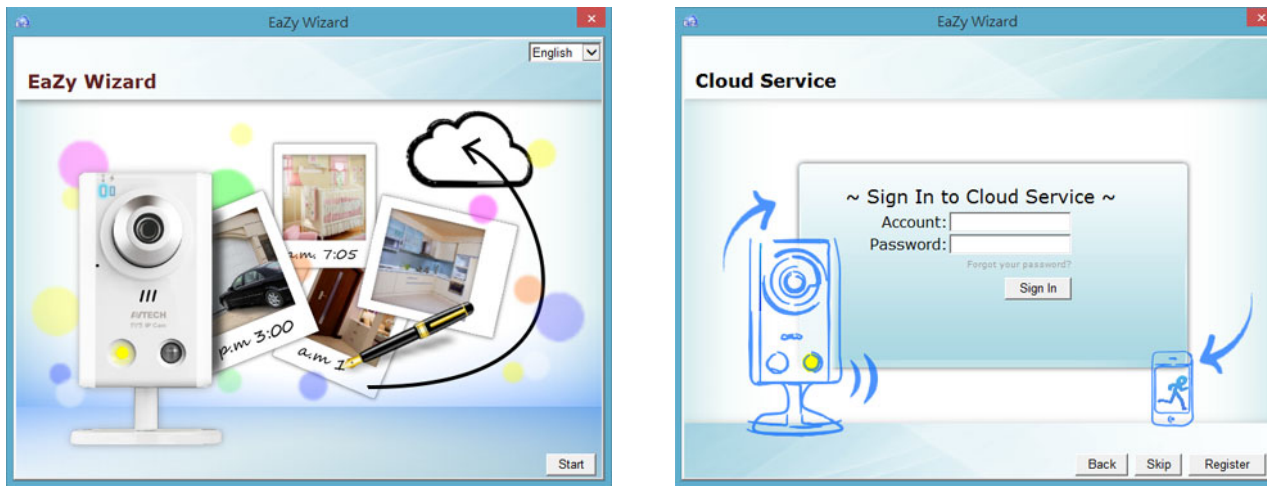

Step6: Select the recorder picture, or choose **DVR / NVR** on the bottom right corner. Then, enter the MAC address you wrote down in Step2, and the security code.

Click **Apply** to continue.

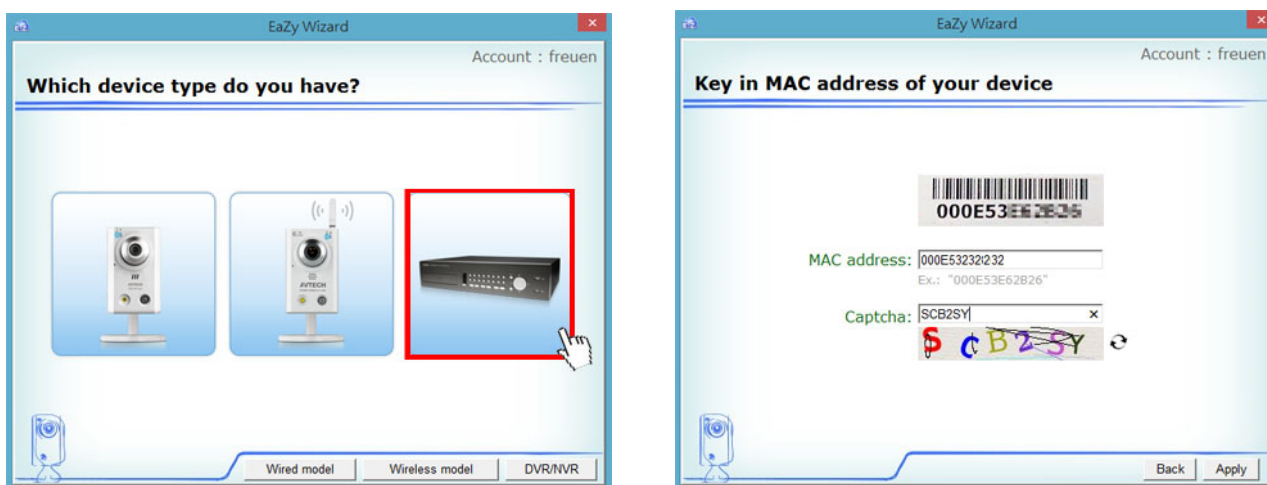

Step7: When your device is found, you'll be directed to the next page to change the device title if you want.

Note: The device name changed here will be fixed and can't be changed later.

Click **Apply** to continue. You'll be prompted to confirm if you want to remove the default user name and password.

- When the default user name and password are removed, you can **ONLY** use the user name and password of the cloud service to access this recorder locally and remotely. If you forget the user name and password of the cloud service, you could only reset the recorder and do all configurations again.
- When the default user name and password are kept, other people might be able to access this recorder if they know the default user name and password of this recorder.

Confirm if you want to keep the default account, and click **Apply** to continue and return to the main page.

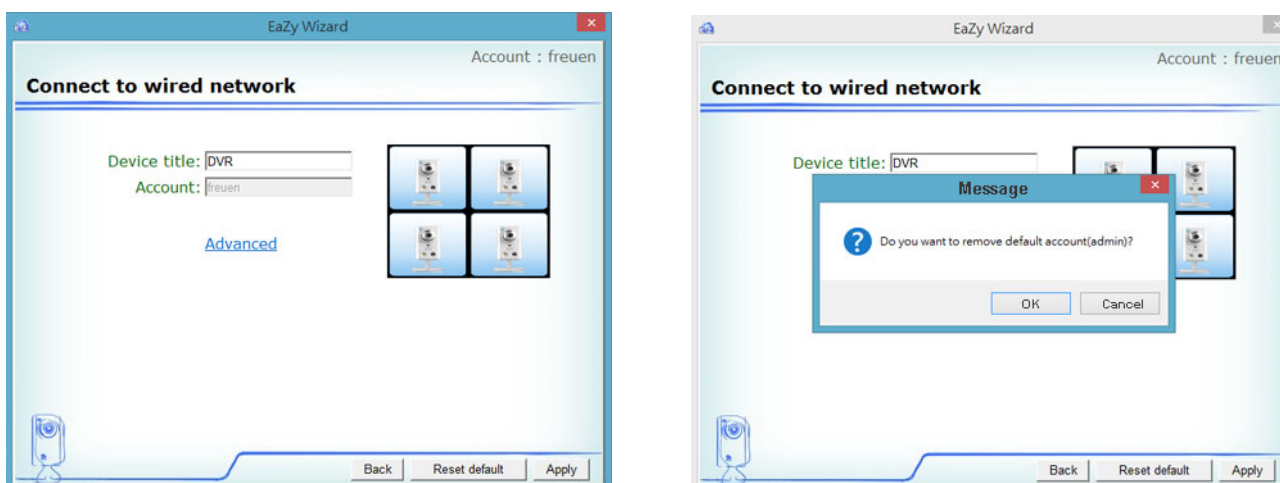

Step8: You'll see the newly-added device with a cloud icon on the left pane. Drag and hold the device to the display area on the right pane to show in the same window, or simply double-click the device to open the device view in another window.

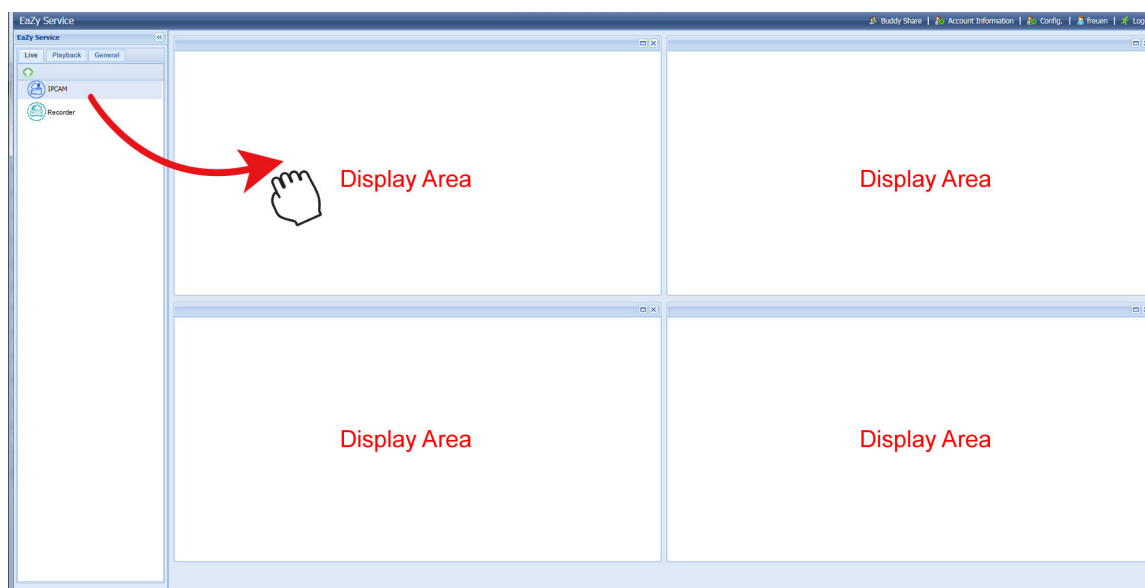

A8.2.2 Checking Remaining Data Allowance

Step1: Log into the cloud service.

Step2: Select **Account Information** on the top right corner to go to account information, and select **Available Data Allowance**.

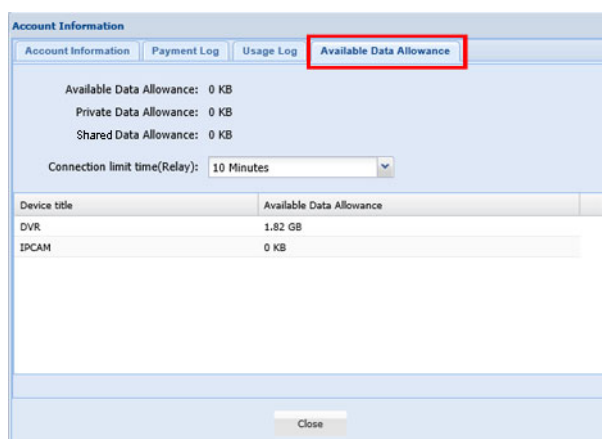

A8.2.3 Sharing Cloud Device Access to Other Account(s)

Note: One cloud device could be shared up to 30 cloud accounts, but the access to the device might be failed because it is still restricted to the maximum online user setup of the device.

Step1: Log into the cloud service.

Step2: Select **Buddy Share** to go to the buddy sharing page. Then, choose the tab **Your own device(s)**, and select **Share With Buddy**.

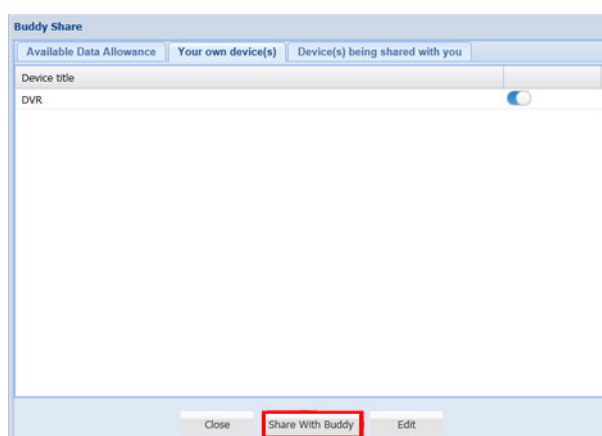

Step3: Choose the cloud device you want to share, and click **Next** to enter the cloud account or the E-mail registered by the account you want to share with. Then, select **Add**.

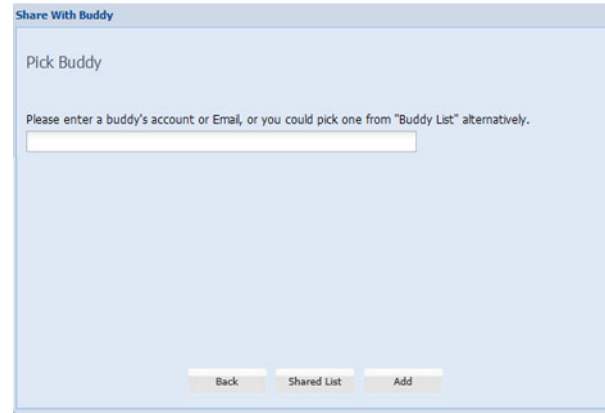

Step4: Check again the account to which you want to share your cloud device.

To add more accounts, select **Add**; to remove the existing account, select **Delete**; to continue buddy setup, select **Next**.

Step5: Specify the access permission of the specified account, which account's data allowance should be consumed after access successfully, and how long the account is allowed to stay after access successfully.

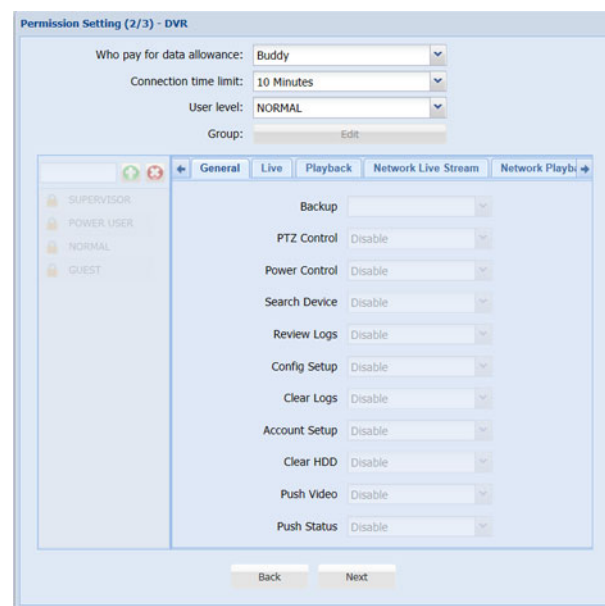
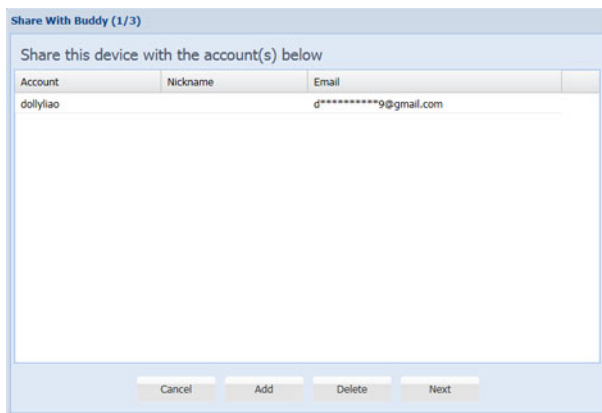

➤ Who should pay data allowance:

Who should pay data allowance	The order to consume data allowance
I	The free data allowance provided by the device -> The additional data allowance shared to other account(s) by the owner -> The additional data allowance of the device's owner -> The data allowance shared to other account(s) by the buddy
Buddy	The additional data allowance of the buddy -> The data allowance shared with other account(s) by the buddy







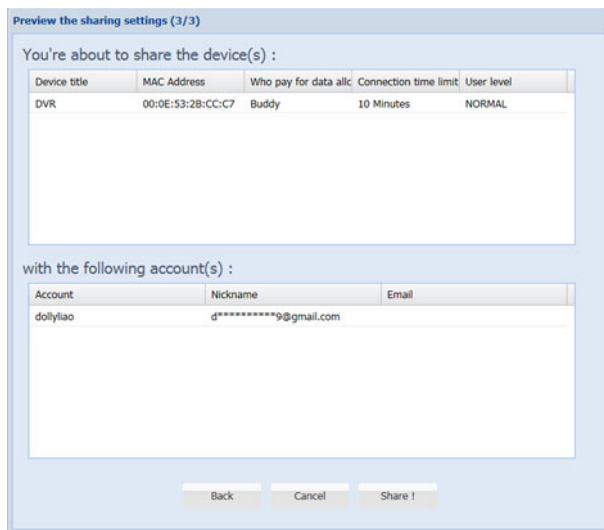

Step6: Check again the configurations you made for the account to which you want to share your cloud device, and select **Share!** to continue.

Step7: (Optional) Configure the data allowance shared to other accounts to use.

Step8: Return to the main page. You'll see the device being shared is marked with an icon of two people.



A8.3 Icons

Icon	Color	Indication
	Teal	This device is a DVR or NVR.
	Blue	This device is an IP camera.
	Orange	This device is an IP speed dome camera.
	Red	This device is disconnected and unidentified.
 or 	Depending on the device color	This device is configured to the Internet via EaZy Networking (Cloud Service). The cloud icon will be grayed out if the EaZy server can't be connected.
	Depending on the device color	You've shared the access right of the device with other cloud account via Buddy (Cloud Service). The icon will be grayed out if you disable the device share.
	Depending on the device color	The icon will be grayed out if the device share is disabled by the owner of the device.

For example, if you see  as the device type, you'll know:

- This device is an IP camera.
- This device is connected to the Internet via EaZy Networking.
- You were shared with the access right of the device, but the device share is disabled now.